

Cartosat-1

DATA USER'S HANDBOOK



National Remote Sensing Agency

CARTOSAT - 1

DATA USER'S HANDBOOK

DOCUMENT CONTROL AND DATA SHEET

1. Report No. and date	:	CARTOSAT-1/NRSA/NDC/HB-09/06 September 2006
2. Title and subtitle	:	CARTOSAT-1 Data User's Handbook
3. Type	:	Technical, Reference
4. No. of pages	:	
5. Compiled and Edited by	:	NRSA Data Center
6. Originating Unit	:	National Remote Sensing Agency (NRSA)
7. Contributing Units	:	ISRO Satellite Centre (ISAC), Bangalore ISRO Telemetry, Tracking and Command Network (ISTRAC), Bangalore Space Applications Centre (SAC), Ahmedabad Earth Observation System, ISRO HQ, Bangalore National Remote Sensing Agency (NRSA), Hyderabad
8. Abstract	:	A reference document containing information regarding Cartosat-1 mission, orbit and coverage, sensors, data reception, data processing, products, services and dissemination.
9. Key words	:	Cartosat-1, PAN Aft, PAN Fore, OBSSR, Stereo, Wide Mono, Data Reception, Orbit and Coverage, Referencing Scheme, Path/Row, Pitch bias, roll bias, yaw bias, Payload Programming, Stereo Strip Triangulation, Data Processing, Products, Services, Digital Browse, User Order Processing System, Dissemination
10. Security Classification	:	Unrestricted
11. Distribution	:	Remote Sensing Data Users' Community

CONTENTS

Section	Page No.
ORGANISATION OF THE HANDBOOK	
1. INTRODUCTION	
1.1 INDIAN EARTH OBSERVATION PROGRAMME	12
1.1.1 Goal	12
1.1.2 Indian Remote Sensing Programme	12
1.1.2.1 Scope	12
1.1.2.2 Indian Remote Sensing Satellite Missions	12
1.1.2.3 Future IRS Satellite Missions	13
1.2 MISSION OVERVIEW	15
1.2.1 Background	15
1.2.2 Mission Objectives	15
2. SPACE SEGMENT	
2.1 SYSTEM OVERVIEW	16
2.2 SPACE SEGMENT	17
2.3 PAYLOAD AND DATA HANDLING SYSTEM	20
2.4 ORBIT AND COVERAGE	21
3. GROUND SEGMENT	
3.1 GROUND SEGMENT OVERVIEW	24
3.2 TTC AND SPACECRAFT CONTROL CENTRE	25
3.2.1 Introduction	25
3.2.2 Spacecraft operations	25
3.2.3 TTC network	25
3.2.4 TTC Ground Station Configuration	25
3.2.5 Functional requirements of TTC network	26
3.2.5.1 Telemetry	27
3.2.5.2 Telecommand	27
3.2.5.3 Tracking	27
3.2.5.4 Data communication	27
3.2.6 Spacecraft Control Centre	27
3.2.6.1 Flight Dynamics operations	28
3.2.6.2 Multi-Satellite Scheduling System	28
3.2.7 Payload Programming	28

Section	Page No.
3.3 DATA RECEPTION STATION	29
3.3.1 Introduction	29
3.3.2 Data Acquisition System	29
3.3.3 Antenna and Receive Systems	29
3.3.3.1 Antenna System	29
3.3.3.2 Tracking Pedestal	29
3.3.3.3 Servo System	30
3.3.3.4 Receiving System	31
3.3.3.5 Cartosat-1 X-band link calculations	32
3.3.4 Data Archival and Level-0 System	32
3.3.4.1 Direct Archival and Quick Look Browse (DAQLB) System	32
3.3.5 Network Systems	34
3.3.6 S-band SPS Data Acquisition System	35
3.3.7 Timing Systems	36
3.3.8 Data Serializer System	36
3.3.9 Datapath Controller	37
3.4 DATA PRODUCTS GENERATION FACILITY	39
3.5 IMAGING (FILMING) SYSTEM	41
3.5.1 Large Format Filming System (LFFS)	41
3.5.2 Small Format Filming System (SFFS)	41
3.6 PHOTO PRODUCTS GENERATION SYSTEM	44
3.7 QUALITY ASSURANCE	46
3.7.1 General criteria	46
3.7.2 Photo products criteria	46
3.7.3 Digital product criteria	46
3.7.4 Geometric Data Quality Control (GDQC)	48
3.7.5 Screening and validation of sensitive areas/ masking in LISS-IV products	48
3.8 DATA QUALITY EVALUATION	49
3.9 INTEGRATED INFORMATION MANAGEMENT SYSTEM	51
4. REFERENCING SCHEME	
4.1 Introduction	52
4.2 Path	52
4.3 Row	52
4.4 Scene definition	52
4.5 Use of referencing scheme	53
4.6 Referencing scheme and scene coverage	53
4.7 Determination of observation dates	53
4.8 Estimation of Path and Row, local clock time and other	54

Section		Page No.
	details for any point on Indian sub-continen	54
4.9	Framing procedure and scene centre and corner co-ordinates evaluation for the referencing scheme	54
4.10	Deviations of orbit and attitude parameters and its effect on the image	55
4.11	Orbit determination and prediction errors	56
4.12	Deviation of attitude parameters	56
4.13	Image framing during actual operations	57
4.14	Impact of the deviations on overlap and side lap during operational lifetime	57
4.15	Accuracy of orbit and attitude parameters used for generating data products	58
5. DATA PRODUCTS		
5.1	Introduction	75
5.2	Types of products	75
	5.2.1 Standard Products	76
	5.2.2 Orth Rectified Products	79
5.3	Product Options	79
5.4	Stereo Strip Triangulation	80
5.5	Digital data products	80
	5.5.1 RPC file	80
	5.5.2 Metadata file format	80
6. SERVICES AND DATA DISSEMINATION		
6.1	INTRODUCTION	82
6.2	USER ORDER PROCESSING SYSTEM	83
	6.2.1 Introduction	83
	6.2.2 User order processing	83
	6.2.3 Services	84
	6.2.4 Order Processing and monitoring on Intranet by NDC	89
	6.2.5 Off-line Order placing by NDC	91
	6.2.6 Stand Alone Services	91
6.3	DIGITAL BROWSE FACILITY	92
	6.3.1 Introduction	92
	6.3.2 Search for images based on date of pass	92
	6.3.3 Search for images based on Path	94
	6.3.4 Geographical area based Query	95
	6.3.5 Map sheet number based Query	96
	6.3.6 Latitude-longitude based Query	97

Section	Page No.
6.3.7 Location name based Query	98
6.3.8 Data ordering	98
6.4 PAYLOAD PROGRAMMING SYSTEM	99
6.4.1 Introduction	99
6.4.2 Programming Requests	100
6.4.3 Programming Services	100
6.4.4 Programming Sequence and Time line	100
6.5 DATA DISSEMINATION	108
6.5.1 Introduction	108
6.5.2 Cartosat-1 Data Distribution	108
6.5.3 Data Down Link Access	108
6.5.4 Upgradation / Establishment of Ground Station	108
6.5.5 Data delivery	108
 7. ANNEXURES	
I Catosat-1 Product codes	111
II Cartosat-1 data order form	112
III Acronyms	118

LIST OF FIGURES

Description	Page No.
2.4.1 Ground trace pattern	22
2.4.2 Scene layout of a Stereo scene	23
2.4.3 Coverage due to roll tilt capability	23
3.2.1 IRSTRAC functional organisation for Cartosat - 1 mission support	26
3.3.1 Block Diagram of Cartosat-1 Data Reception system	30
3.3.2 Level-0 DAQLB System	33
3.3.3 Level-0 Network connectivity	35
3.3.4 SPS Direct Archival System	36
3.3.5 Timing System block diagram	37
3.3.6 Block diagram of Data Serializer System	38
3.4.1 Cartosat-1 Data Processing system block diagram	40
3.5.1 Photo product template for precision products	42
3.5.3 Imaging process flow chart	43
3.6.2 Photo products Generation flow	45
3.7.1 Flow chart for Generation of photo products	47
3.7.2 Flow chart for Generation of standard and ortho digital products	47
3.8.1 DQE Activity flow diagram	59
3.8.2 DQE s/w system	50
4.1 Stereo Scene coverage	53
4.2 Stereo Scene layout	54
5.1 Outline of AOI Product (single)	77
5.2 Outline of AOI Product (multiple scenes)	77

Description		Page No.
5.3	File naming of AOI product	77
6.2.1	Block diagram of User Order Processing System	83
6.2.2	UOPS Home page	84
6.2.3	Page displaying the UOPS Services	85
6.2.4	Page displaying input mode options	85
6.2.5	Page displaying product options	86
6.2.6	Page displaying scenes covering the area of interest during the desired period	86
6.2.7	Page displaying selected scene and its layout	87
6.2.8	Page displaying product options	88
6.2.9	Page displaying details of the order	89
6.3.1	Browse queries main form	92
6.3.2	Date base query form	93
6.3.3	Path based query form	94
6.3.4	Geographical area based query form	95
6.3.5	Map sheet number based query form	96
6.3.6	Latitude-longitude based query form	97
6.3.7	Location Name based query form	98
6.4.1	Roll tilt capability of Cartosat-1	99
6.4.2	Overall flow of the programming activities	101
6.4.3	Typical Programming request form	103
6.4.4	Typical Programming request status form	104
6.4.5	IGS request form	105
6.5.1	Flow of data transfer	109

LIST OF TABLES

Description	Page No.
2.4.1 Cartosat-1 orbit	21
2.4.2 Overlap and sidelap between the scenes	21
3.1.1 Ground segment elements and functions	24
3.2.1 Characteristics of ISTRAC network stations	27
3.2.2 Specifications of Antenna and Tracking Pedestal System	30
3.2.3 Specifications of Servo System	31
3.2.4 Specifications of Receiving System	32
3.6.1 Photographic Equipments and Functions	44
3.7.1 Specifications of photographic masters	46
3.7.2 Specifications of photo prints	46
4.1 Cartosat - 1 Path Calender for the Year 2006	59
4.2 The difference in longitude between a given row and equator	65
4.3 Equatorial crossing longitude for paths over Indian region	69
4.4 Equatorial crossing time (GMT) for paths over Indian region	71
5.1 Cartosat-1 data products	75
5.2 Standard products	76
5.3 Precision (ortho) products	79
5.4 Product Options	79
5.5 RPC file format description	81
6.4.1 Programming sequence and timeline	101

ORGANIZATION OF THE HANDBOOK

The Cartosat-1 Data User's Handbook is published to provide essential information to the users about the mission - the sensors, orbit and coverage, referencing scheme, data acquisition, products, and services.

Chapter 1 provides an overview of the Indian Earth Observation Programme and the Cartosat-1 mission.

Chapter 2 provides an overview of Cartosat-1 space segment elements such as, data handling system, payload, orbit and coverage.

Chapter 3 covers various aspects of Cartosat-1 ground segment elements such as mission operations and control centre; data acquisition, archival, generation and processing systems.

Chapter 4 deals with the referencing scheme pertaining to Cartosat-1.

Chapter 5 provides information on the various products provided by this mission.

Chapter 6 provides information on the various services provided by NDC and data dissemination schemes.

1.1 INDIAN EARTH OBSERVATION PROGRAMME

1.1.1 Goal

The goal of the Indian Space Programme is to harness space technology for applications in the areas of communications, broadcasting, meteorology, disaster warning, search and rescue operations and remote sensing. Operational systems have been realised in all the above areas during the past two decades. The remote sensing component of the programme, in particular, has successfully achieved global acceptance. Operational satellites have been indigenously built and launched, which cater to land and ocean applications.

1.1.2 Indian Remote Sensing (IRS) Programme

1.1.2.1 Scope

Remote sensing is an important part of the Indian Space Programme and the Department of Space (DOS), Government of India, is the nodal agency for the realisation of the National Natural Resources Management System (NNRMS), the National Resources Information System (NRIS) and the Integrated Mission for Sustainable Development (IMSD), besides several other national level application projects like Crop Acreage and Production Estimation (CAPE), National Drinking Water Mission and Wasteland Mapping etc., in close collaboration with the user agencies.

As a part of this programme, DOS has acquired the capability to design, develop and operate state-of-art multi-sensor satellite based systems comprising of space, ground and application segments to meet domestic and international requirements. The department also successfully operationalised the launch vehicle programme for the remote sensing satellites.

1.1.2.2 Indian Remote Sensing Satellite Missions

The following satellite missions are the important milestones, which have been crossed, in the realisation of indigenous end-to-end remote sensing capabilities.

Bhaskara 1 and 2 :

These were experimental remote sensing satellites launched in June 1979 and November 1981 respectively. Their payload consisted of TV cameras and radiometers. These satellites provided hands-on experience in achieving the goal of the Indian Space Programme.

IRS-1A and 1B :

These two satellites, launched in March 1988 and August 1991 respectively, were the first generation, operational remote sensing satellites. The two identical satellites carried Linear Imaging and Self Scanning sensors (LISS-1 and LISS-II (2)) for providing data in four spectral bands with a resolution of 72.5m and 36.25m respectively with a repetivity of 22 days. These two satellites, during a period of more than a decade of operations, provided vital data for several national level projects.

IRS-P2 :

This satellite was launched in October 1994 using the indigenously developed Polar Satellite Launch Vehicle (PSLV-D2). IRS-P2 carried a modified LISS camera.

IRS-1C and IRS-1D :

These two satellites, launched in December 1995 and September 1997 respectively, are the second generation, operational remote sensing satellite missions with improved sensor and coverage characteristics.

The three sensors on-board the satellites are :

* A PAN sensor with a spatial resolution of 5.8m (at nadir) in a single band in the visible region, with a swath of 70 Km (at nadir) and across track steerability of +/- 26 degrees.

* A LISS-III multi-spectral sensor with a spatial resolution of 23.5m, operating in the visible, near infra-red bands and 70.5m resolution in the short-wave infra-red band, with a swath of 141Km.

* A Wide Field Sensor (WiFS) sensor with a spatial resolution of 188m, two spectral bands in the visible and near infra-red regions, with a swath of 810 Km.

These two satellites are providing data that can be used for resource mapping up to 1:25,000 scale. Several applications have exploited the improved capabilities of these two missions.

IRS-P3 :

This satellite was launched in April 1996 by the PSLV-D3. The payload consists of two imaging sensors and one non-imaging sensor. The Wide Field Sensor (WiFS) sensor is providing data with a spatial resolution of 188m in three spectral bands, in the visible and near infra-red regions, with a swath of 810 Km. The other two sensors on-board are a Modular Opto-electronic Scanner (MOS) and an X-ray astronomy payload. WiFS and MOS data products are being disseminated to users.

OCEANSAT-1 (IRS-P4) :

This satellite was launched in May 1999. The payload consists of an Ocean Color Monitor (OCM) operating in eight spectral bands in the visible and infra-red region and a Multi-frequency Scanning Microwave Radiometer (MSMR), operating in four frequencies namely 6.60, 10.61, 18 and 21 GHz. These sensors are providing data for measuring the physical and biological parameters of oceans.

RESOURCESAT-1 (IRS-P6):

This satellite was launched in October 2003 and is

a mission with improved sensor and coverage characteristics.

The three sensors on-board the satellites are :

* A LISS-IV sensor which can be operated in two modes : multi-spectral and Mono mode. This sensor provides data with a spatial resolution of 5.8m (at nadir) in both the modes.

In the Mono mode, the sensor provides data of a single band in the visible region, with a swath of 70 Km (at nadir) and across track steerability of ± 26 degrees. In the multi-spectral mode, the sensor provides data of three bands with a swath of 23Km.

* A LISS-III multi-spectral sensor with a spatial resolution of 23.5m, operating in the visible, near infra-red band and short-wave infra-red band, with a swath of 141Km.

*An Advanced Wide Field Sensor (AWiFS) sensor (two electro-optic modules AWiFS-A and AWiFS- B) with a spatial resolution of 56m, four spectral bands in the visible and near infra-red regions, with a composite swath of 740 Km. This sensor provides data with 10 bit quantization.

CARTOSAT-1 (IRS-P5) :

Cartosat-1 was launched on May 05,2005. This satellite carries two PAN sensors with 2.5m resolution and fore-aft stereo capability. The payload is designed to cater to applications in cartography, terrain modeling, cadastral mapping etc.,. This handbook discusses the various aspects of the mission at length.

1.1.2.3 Future IRS satellite Missions

Encouraged by the successful operations of the above mentioned missions, a number of missions are planned for realisation in the next few years. These missions are designed to carry suitable sensors for applications in large scale mapping, oceanography and atmospheric studies and microwave remote sensing.

CARTOSAT-2 :

This satellite will be placed in a polar, Sun synchronous orbit at an altitude of 630 km and a local mean time - 9.30 A.M. This satellite will carry a single PAN camera with high agility.

The PAN camera will collect data in 0.45 - 0.85 μ m band with a spatial resolution of 1m and 9.6 km swath. The camera will provide data with 10 bit radiometric resolution.

OCEANSAT-2 :

This satellite mission is conceived to provide continuity of services to the Oceansat-1 data users. This satellite will have enhanced capabilities. It will carry an Ocean Color Monitor (OCM) with some suitable changes in spectral bands as per users' experience with OCM-1 and Wind Scatterometer. Inclusion of a thermal infra-red Radiometer is also under consideration.

RISAT :

This will be the first satellite to be launched by India to operate in the microwave region. The satellite will carry a multi-mode, Synthetic Aperture RADAR (SAR) payload operating in ScanSAR strip and Spotlight modes to provide images with coarse, fine and high spatial resolutions respectively. Some of the potential applications of the SAR data are Ship detection and Oil pollution monitoring, paddy crop acreage and yield estimation, flood inundation mapping, ship routing and snow mapping.

1.2 IRS-P5 (Cartosat-1) MISSION OVERVIEW

1.2.1 Background

The Cartosat-1 mission envisages to support the implementation of satellite based remote sensing for earth resources survey and measurement, mainly for cartographic applications. It weighs 1560 kgs and was put into 618 km Sun synchronous orbit on May 05, 2005.

The principal components of the IRS-P5 (Cartosat-1) mission are.

- * An advanced 3-axis body stabilized, body steerable remote sensing satellite.
- * A ground based data reception, recording and processing system.
- * Ground system for in-orbit satellite control.
- * Hardware/software elements for the generation of

user oriented data products, data analysis and archival.

1.2.2 Mission Objectives

The Primary objectives of Cartosat-1 mission are:

- * To design and develop an advanced 3-axis body stabilized remote sensing satellite for providing data with enhanced spatial resolution (better than 2.5 m) and along track stereo imaging capability for cartographic applications.
- * To further stimulate new areas of user applications in the areas of cartographic applications, urban management, disaster assessment, relief planning and management, environmental assessment and other GIS applications.

2.1 SYSTEM OVERVIEW

Cartosat-1 is a three axis body stabilized spacecraft, which was put into 618 km Sun synchronous orbit by an indigenous launch vehicle PSLV-C6. The nominal mission life is five years. Cartosat-1 has two panchromatic cameras mounted with a tilt of +26 degrees (Fore) and -5 degrees (Aft) from yaw axis in Yaw-Roll plane.

The platform is continuously steerable about spacecraft body-yaw to compensate the earth rotation correction and thus allow both Fore and Aft cameras to look at the same ground strip with certain time gap, of the order of 52 seconds, providing stereoscopy.

Fore Camera :

The Fore camera provides an across track resolution of 2.452 m (at Nadir). It covers a swath of 29.42 km. The Fore camera can be tilted upto ± 23 degrees in the across track direction, thereby providing a revisit period of 5 days. The resolution of the camera when tilted by 25 deg is 2.909m, resulting in a swath of 34.91 km.

Aft Camera :

The Aft camera provide an across track resolution of 2.187 m (at Nadir). It covers a swath of 26.24 km. The Aft camera can be tilted upto ± 23 degrees in the across track direction, thereby providing a revisit period of 5 days. The resolution of the camera when tilted by 25 deg is 2.789 m, resulting a swath of 33.47 km.

Both the cameras operate in the 0.5-0.85 microns spectral band. For both the cameras, steering is done through body rotation.

The Cartosat-1 spacecraft mainframe is configured with several new features and enhanced capabilities to support the payload operations (station switch over during a single pass and data transmission to multiple stations). The payload can be operated either

in real time mode by direct transmission to ground station or in Record- Playback mode using a 120 Gb On-Board Solid State Recorder (OBSSR). The various modes of payload operations can be programmed apriori, through the Tele Command Processor (TCP).

The Ground Segment consists of :

- * A Telemetry Tracking and Command (TTC) segment comprising of a TTC network to provide optimum satellite operations and a Mission Control Centre for mission management, spacecraft operations and scheduling.

- * An Image segment comprising of data reception, data acquisition, data processing and product generation systems along with centralized data dissemination centre.

The functions of the Ground segment are:

- * Telemetry, tracking and command.
- * Mission control
- * Data reception
- * Data products generation and dissemination.

2.2 SPACE SEGMENT

The Space segment of Cartosat-1 performs the following functions.

- * Provides images in panchromatic band from a two camera system to get stereoscopic imagery.
- * Formats the payload sensor data along with auxiliary information and transmit the same to the ground station in two X-band carriers either in real time or as playback of on-board recorded data.
- * Provides necessary power for main frame subsystems and payload operations with a positive power margin.
- * Provides required pointing accuracy and platform stability during imaging.
- * Provides the required yaw steering on the platform to support stereoscopic mode imaging, catering four different combinations for the view directions of Fore and Aft cameras.
- * Maintains the proper orbit by periodic correction maneuvers.
- * Transmits house keeping information of various subsystems and accepts tele commands to control the spacecraft.

The structure of the spacecraft consists of a Main Platform (MPL) and a Payload Platform (PPL). The MPL consists of main cylinder assembly, four vertical panels, top deck and bottom deck. The cylinder assembly comprises of a central load bearing cylinder, satellite interface ring and top ring. The top ring of the cylinder interfaces with the top deck. All the four consist of a CFRP cone, PPL deck, wedges for camera mounting, bracket to mount the payload electronic package near to the Detector Head assembly, and star sensor mounting wedge. The CFRP interface cone isolates the PPL Deck and the

MPL. The two cameras are encompassed within a thermal cover assembly with two hoods and anchored to the PPL deck.

The inner and the outer sides of the Equipment Panels, top deck and bottom deck carry the subsystem package. All the sensors and the antennae are mounted on the outer surface of the equipment panels, top/ bottom decks. The sun side and the anti sun side Equipment panels of 40 mm thick support the solar arrays and the power transfer assemblies (SADA). The bottom deck carries most of the RCS elements and digital sun sensor (south).

A CFRP cone of 338mm height isolates MPL and PPL decks. The PPL deck is made stiff enough to hold all the elements accommodated on it. It comprises of a CFRP cone, PPL deck, wedges for camera mounting, bracket to mount the payload electronic packages near to the detector Head Assembly, and a support for star sensor mounting.

The power system of Cartosat-1 consists of six deployable solar panels, with three panels in each wing (sun side and anti sun side), each panel of size 1.4 m X 1.8 m . These solar arrays are deployed immediately after spacecraft separation from the Launcher using deployment mechanism. Then onwards they are continuously rotated to track the Sun using Solar Array Drive Assembly (SADA). In order to continuously orient the solar arrays towards the sun in a earth oriented spacecraft, the array drive motors are made to step periodically. In order to minimize the periodic disturbance to the spacecraft, "micro-stepping" scheme is implemented. A potentiometer is incorporated in each SADA mechanism for panel position monitoring with respect to satellite body. Two Solar panel sun sensors provide the position error of each solar array with respect to the Sun vector which will be automatically corrected by SADA electronics if SADA is driven in sensor-dependent mode. The solar arrays generate a power of 1050 watts at end-of-life (EOL). Further, to support the energy requirements

during eclipse period and peak loads, two batteries, each of capacity 24 AH have been provided. Average depth of discharge is limited to < 15% so as to meet 5 years of mission life. Power bus is formed by ohmic interconnection of solar array strings (current source) and battery (voltage source). There are two raw bus lines called Bus-A and Bus-B. Raw bus is essentially the battery whose voltage ranges from 28V to 42V. Bus control is by PWM based taper charge regulator (TCR).

The TTC system is configured to work in S-band and comprises of three sub-systems - Telemetry, Tele command and Transponder. The Telemetry system collects the house keeping (HK) data from each subsystem, formats and modulates on to the sub-carrier. There are two formats viz., Dwell and Normal which can be simultaneously received. The system operates in storage mode also. In this mode, data pertaining to a maximum of five orbits can be stored in semiconductor memory during non-visibility period. The telemetry data is transmitted at 1 kbps in normal mode and 16 kbps in play-back mode. Real time house keeping data is transmitted on a sub-carrier of 25.6 KHz. Either dwell data at 1024 bps or stored house keeping data at 16 kbps or Star-Sensor data at 16 kbps or SPS data at 16 kbps can be transmitted on a separate sub-carrier of 128 KHz.

The Tele command system incorporates shortened BCH code for error free command message reception. It provides time-tagged command execution facility with edit, block execution and memory error detection features implemented using 80C86 microprocessor. It provides time tag command execution, on-board (OBT) based command execution facilities configurable command block execution facilities. A Micro-processor based Tele Command Processor (TCP) is programmed to execute a pre defined sequence of commands under various Payload operations (real time, calibration and record / playback). Facility exists to have multiple (at most sixteen) payload operation sequences simultaneously.

The TTC transponder transmits the telemetry data, receives the telecommand signals, demodulates the ranging tones and re-transmits them to ground with a fixed turn around ratio of 240/221 to enable measurement of two-way Doppler. The Transponder system consists of receiving and transmitting system and can operate in a coherent or non coherent mode. In coherent mode, the downlink carrier is derived by PLL technique from the uplink signal. In non-coherent mode, the downlink carrier is derived from an independent TCXO.

The Attitude and Orbit Control System (AOCS) supports the functions of Earth acquisition after launch, three axes body stabilization as well as orbit maintenance throughout the mission life. The AOCS is configured with a Micro-processor based control electronics with hot redundancy. The control electronics receives the attitude error measurements from sun-sensors, earth sensors, star trackers, magnetometers, gyroscopes and drives the actuators – reaction wheels, magnetic torquers and RCS thrusters to minimize the attitude errors. There are several special logics and features like auto-acquisition sequence, safe mode, auto – reconfiguration of reaction wheels in case of a single wheel failure, MTC logic for momentum dumping, spacecraft position and velocity determination using GPS system.

The Reaction control system of Cartosat-1 is a monopropellant Hydrazine system using Nitrogen as pressurant and operating in a blow-down mode. The reaction control system is used for correcting the satellite injection errors in attitude and inclination, attitude acquisition and maintenance of the desired sun synchronous orbit . Eight nos. of 1 Newton and four 11 Newton thrusters are mounted on the bottom deck.

The Thermal control system maintains the temperature of different subsystems within the specified limits using semi-active and active thermal control elements like paints, Multi Layer Insulation (MLI) blankets, Optical Solar Reflectors and auto-temperature controllers All the surfaces of PAN cameras are thermally treated with black paint. All

Mirror Fixing Devices (MFD) are provided with black tapes. Payload CCD cold finger is connected to heat pipe by a copper braid. Each CCD has one heat pipe which runs over the thermal cover and get attached to the sun side radiator plate and anti-sun side radiator plate respectively.

2.3 PAYLOAD AND DATA HANDLING SYSTEM

The payload system of the Cartosat-1 consists of two panchromatic cameras mounted with a tilt of +26 deg (Fore) and –5 deg (Aft) from yaw axis in Yaw Roll plane. Both cameras are identical in optical, mechanical and electrical design. It also has off-nadir capability upto +/- 23 deg by providing roll biasing in the orbit reference frame. CCD with 12K silicon photo sensitive elements of 7 x 7 micron linear array is used as detector. It has eight output ports. In this CCD the odd and even pixels rows are physically separated by 5 lines i.e. 35 microns. The cameras are with an instantaneous geometrical field of view (IGFOV) of 2.5 m with a swath of about 30 km. The data rate for each camera with the quantization of 10 bits of the digital video data is 336 Mbps with data saturation set to 100% albedo. This video data are compressed, encrypted, formatted and transmitted to ground at a data rate of 105 Mbps for each camera through two X-band QPSK carriers. The compressed and formatted data can be stored in 120 Gb Solid State Recorder (SSR). The Data compression ratio is 3.2 : 1 and the Compression type is JPEG. Onboard calibration is done with 16 LEDs.

The Payload system consists of an Electro optic module, Payload Electronics and Power Electronics. The Electro-optic module consists of OFF axis three mirror optical system and a detector head assembly consisting of 12K charge coupled device, a spectral band pass filter and calibration LED's. The optical system for the payload is an extended version of the Panchromatic camera of the IRS-1C/1D i.e. an unobscured off axis reflective system. The effective focal length of optical system is 1945 mm and F-number is 4.0. The detector is a 12K CCD which is mounted in a detector head assembly, one for Fore payload

and one for Aft payload. The main functions of the camera electronics are high detector read out, precision signal processing, data generation in addition to meeting the functional requirement of the camera. The camera electronics is designed for 12K – 8 port CCD from Thomson CSF.

The video data from the two cameras are compressed, encrypted, RS encoded, formatted and transmitted to ground at a data rate of 105 Mbps for each camera through two X-band QPSK carriers by the Base band data-handling system. Formatted data from two cameras is to be stored in a 120 Gb capacity Solid state recorder for playback at a later time. BDH consists of the following systems

- * JPEG like compression system (DCS)
- * Clock and formatter system
- * 120 Gb Solid State Recorder.

The PAN-Fore and PAN-Aft data are transmitted to ground stations on X-Band carriers using QPSK modulation. After the data formatting is done by BDH and sent to RF data handling system as TTL signals, the Fore camera data are transmitted on 8125 MHz carrier and Aft camera data are transmitted on 8300 MHz carrier. Primary mode of transmission is through Phased Array Antenna (PAA) with single beam. Single chain of shaped beam antenna with TWTA amplifier for two carriers is a back up option for PAA. Cartosat-1 carries a C-band Transponder which is used for dynamic calibration. C-band Radars have been installed at different ISRO ground stations.

2.4 ORBIT AND COVERAGE

The primary objective of Cartosat-1 mission is to provide systematic acquisition of stereo data for the earth's surface under nearly constant illumination conditions. The satellite operates in a circular, sun-synchronous, near polar orbit with an inclination of 97.87 deg, at an altitude of 618 km. The satellite takes 97.18 minutes to complete one revolution around the earth and completes about 15 orbits per day. The entire earth is covered by 1867 orbits during a 126 day cycle. The orbital parameters are summarized in Table 2.4.1.

Orbits/cycle	1867
Repeat cycle	126 days
Altitude	618 km
Semi-major axis	6996.132 km
Inclination	97.87 deg
Eccentricity	0.001
Period	97.18 minutes
Distance between adjacent traces	21.46 km
Distance between successive ground tracks	2704.6 km
Ground track velocity	6.94 km/sec

Table 2.4.1 Cartosat-1 orbit

The mean equatorial crossing time at descending node is 10:30 a.m. ± 5 minutes. The orbit adjust system is used to attain the required orbit initially and it is maintained throughout the mission period. The ground trace pattern is controlled within ±1 km

of the reference ground trace pattern. The two cameras collect data with different swaths. The Fore camera which is canted at +26 deg in the along track direction provides a swath of 30 km and the Aft camera which is canted at -5 deg in the along track direction provides a swath of 26.8 km. Apart from this, different pitch biases of the spacecraft like +5 , -21 and -10.5 deg are planned, which provide different combination of canting.

Details of overlap and sidelap between scenes of a sensor are given in Table 2.4.2. The successive orbits are shifted westward by 2704.6 km at the equator. Figure 2.4.1 shows a typical ground trace of the orbits. The entire globe is covered in 1867 orbits between 81 degrees North and 81degrees South latitudes during the 126 day cycle.

As mentioned earlier the Fore camera and Aft camera are canted with +26 deg and -5 deg respectively. The purpose of the canting is to obtain the along track stereo image of the terrain. This means that whatever terrain is imaged by the Fore camera is to be imaged by Aft camera also, but with different tilt. Since Aft camera lags behind the Fore camera, by the time the Aft camera sees the same latitude, the Earth rotation causes longitudinal shift and it is not possible to image the same terrain. This problem is circumvented by giving appropriate yaw rotation to the spacecraft which is a function of latitude, roll rotation and pitch bias.

Payload (km)	Resolution (m)	Swath (km)	Ground Image size (km X km)	Overlap (km)	Sidelap
Fore Camera	2.452	30	26.8 x 30	1.3	8.5
Aft Camera	2.187	26.8	26.8 x 26.8	1.3	5.3

Table 2.4.2 Overlap and sidelap between the scenes

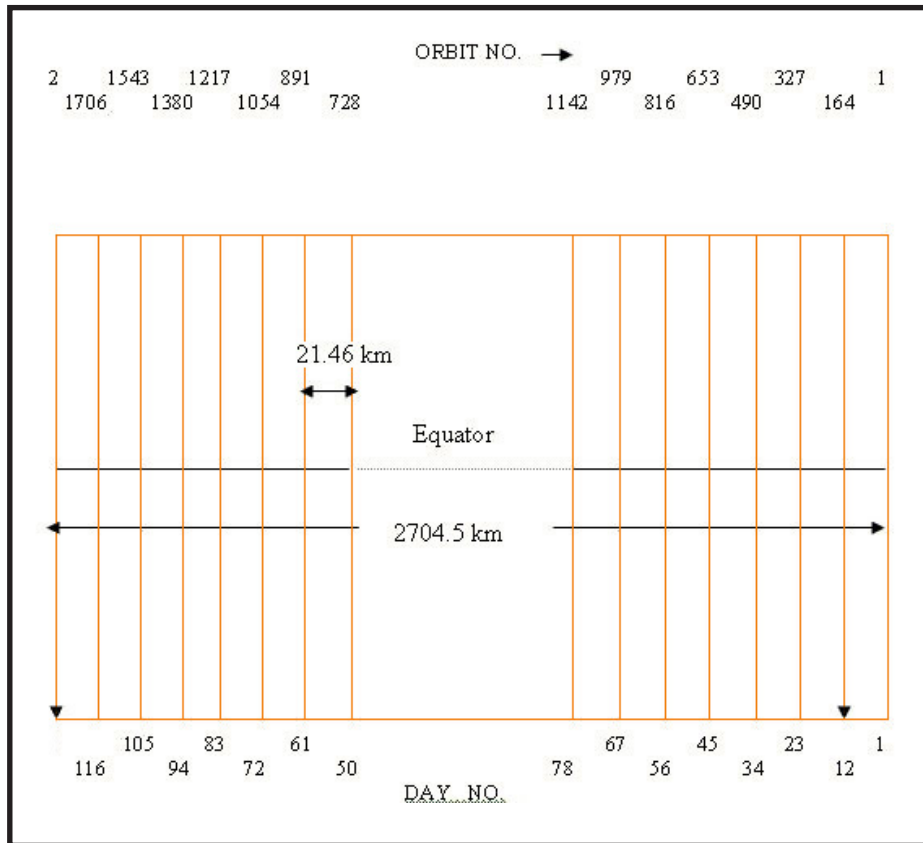

Figure 2.4.1 Ground trace pattern

is discussed in Chapter 4.

Scene layout :

Figure 2.4.2 shows the scene layout of a stereo scene. The Aft camera scene lies within the Fore camera scene. The corners are numbered for Fore camera scene as shown in the figure. Same pattern of marking the corners is followed for Aft camera scene also. Though the swath of Fore camera scene is more than Aft camera scene, the length is considered to be the same for both the scenes. There is an overlap of 1.3 km between adjacent stereo scenes along a path. Also there is a sidelap of 5.3 km between Aft camera scenes of adjacent paths at equator. The sidelap is minimum at equator. As we move away from the equator, the sidelap increases because the paths come closer to each other as we move towards the pole. Typically, at 40 degrees latitude the sidelap is around 49% of the swath. More details about the referencing scheme

Revisit capability :

Because of the agility of the spacecraft to be rotated about the three axes, a given area can be viewed more than once within one cycle. Figure 2.4.3 shows a region on path 1 at equator. Also are shown, the adjacent paths on either side that can view the given region with the roll angle between +10 deg and -23 deg. The day number on which the adjacent paths occur relative to the central path is also provided. From the figure it can also be seen that the maximum wait period to view an area is 11 days. As we go away from equator, paths become closer to each other. Hence, more number of paths can be used to view a given region at high latitudes.

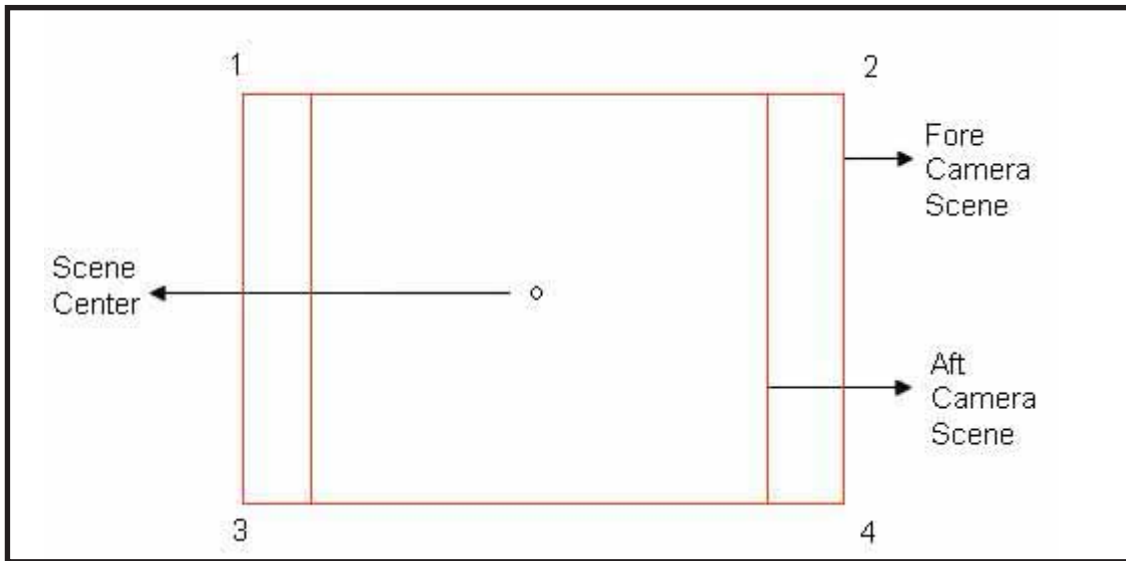

Figure 2.4.2 Scene layout of a stereo scene

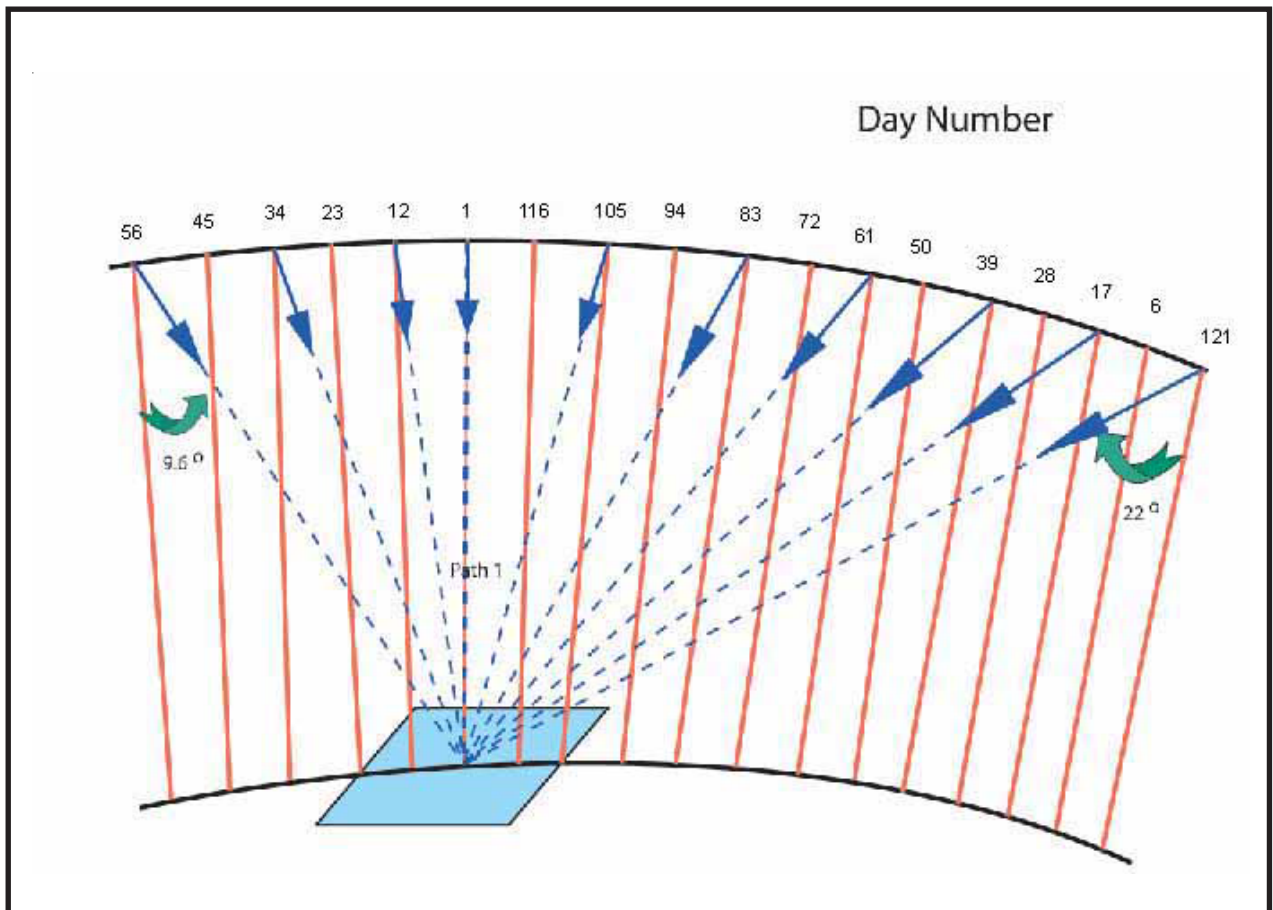

Figure 2.4.3 Coverage due to roll tilt capability

3.1 GROUND SEGMENT OVERVIEW

The main functions of the Ground Segment are :

- Telemetry Tracking and Command
- Mission Control
- Data Reception
- Data Products Generation and Dissemination
- Data Analyses

Telemetry Tracking and Command (TTC) functions are carried out by ISRO Telemetry Tracking and Command Centre (ISTRAC) with its

ground stations located at Bangalore, Lucknow and Mauritius, with selective support from space agencies of Europe, Russia and America. The reception and recording of payload data are done at the earth station of the National Remote Sensing Agency (NRSA), located at Shadnagar, near Hyderabad. Mission Control support is provided from ISTRAC, Bangalore. Data are also transmitted to different International Ground Stations (IGS). The various elements of the Cartosat-1 Ground Segment are given in Table 3.1.1.

Element	Location	Functions
TTC	ISTRAC ground stationa at Bangalore, Lucknow, Biak and Mauritius	<ol style="list-style-type: none"> 1. Satellite house keeping, data reception and recording 2. Spacecraft commanding and tracking
Mission Control	ISTRAC, Bangalore	<ol style="list-style-type: none"> 1. Network coordination and control 2. Scheduling spacecraft operations 3. Spacecraft HK data logging 4. Communication links between concerned ground segment elements
Data Reception	NRSA, Shadnagar	<ol style="list-style-type: none"> 1. Reception and recording of payload and OBTR data 2. Generation of browse imagery 3. Generation of ancillary data for product generation 4. Transfer of all data
Data products Generation, Dissemination and Analyses	NRSA, Balanagar	<ol style="list-style-type: none"> 1. Generation and distribution of different types of data products 2. Data quality evaluation, data and browse archival and management 3. Payload programming and request processing

Table 3.1.1 Ground segment elements and functions

3.2 TTC AND SPACECRAFT CONTROL CENTRE

3.2.1 Introduction

ISTRAC provides telemetry, tracking, telecommand, spacecraft operations and control support for Cartosat-1 mission through its network of ground stations, and Spacecraft Control Centre (SCC). SCC consists of mission control room, mission analysis room, simulation and training facilities, dedicated mission control room, computer facilities, flight dynamic operations and skyline communication facilities etc.,. TTC network comprises of a network of ground stations located at Bangalore (BLR), Lucknow (LCK), Mauritius (MAU), Bearslake (BRK) and Sriharikota (SHAR). A description of the various facilities of ISTRAC and their functional responsibilities with specific reference to Cartosat-1 are provided in the following sections.

3.2.2 Spacecraft operations

The TTC network, Spacecraft Control Centre, data links and the operations team for the essential elements of mission control. In order to fulfill Cartosat-1 mission goals, SCC with the support of ISTRAC network, carries out continuous health monitoring and control of Cartosat-1 in the multi-mission operation environment. Along with this, SCC also schedules and carries out payload operations, viz., PAN Aft, PAN Fore, SSR record/dump operations and SPS data collection.

The spacecraft controllers at SCC interact through voice links with the TTC station to obtain telemetry and tracking support and uplink the scheduled commands during the radio visible segment of an orbit. SCC is equipped with the requisite mission software and display terminals to ensure error-free operations. These operations are carried out on a routine basis to keep the spacecraft in good health, intended orbit and orientation. Anomalies in a spacecraft health and deviation in spacecraft attitude

are tackled by spacecraft controllers by swift action, with the help of mission specific contingency operations management procedures. Ground stations carry out ranging operations collecting range, Doppler and Angles data in order to determine precise orbit for tracking the spacecraft by TTC stations and payload data reception stations.

ISTRAC ground stations located at Bangalore (BLR), Lucknow (LCK), Mauritius (MAU), Bearslake (BRK) and Sriharikota (SHAR) provide the support during initial and normal phase operations.

The ISTRAC functional organization for Cartosat-1 mission support is shown in Figure 3.2.1.

3.2.3 TTC network

Spacecraft mission operations and control require a suitable network of ground stations to plan and execute appropriate telecommand operations on the spacecraft, as per pre-determined timeline. Ground station locations for Cartosat-1 have been chosen on the basis of mission's sequence of events, mission strategies and sufficient radio visibility requirements of important arcs of the orbit.

3.2.4 TTC ground station configuration

ISTRAC TTC stations are equipped with almost identical systems for telemetry (TM) reception, tracking and telecommanding. All ground stations are installed with 10m antenna with a G/T of 19.5 dB. An acquisition antenna equivalent of 1m diameter, mounted on the main antenna system facilities initial acquisition of the satellite. Capability to receive 3 or 4 TM carriers with necessary recording, PCM demodulation and quicklook facilities exist in all the stations. Each station is provided with a complete telecommand system of 2 KW RF power and high precision range and range

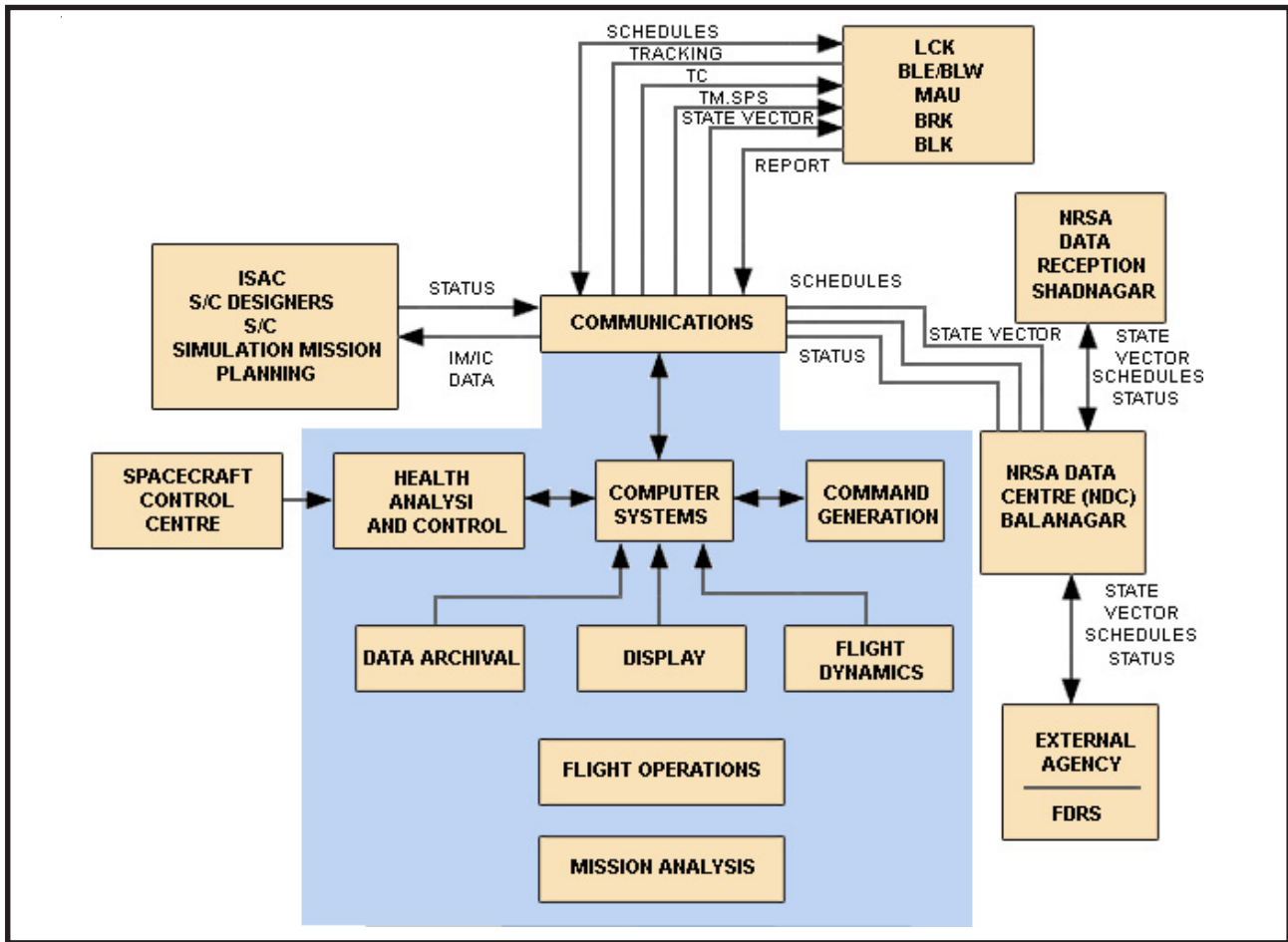

Figure 3.2.1 IRSTRAC functional organisation for Cartosat-1 mission support

rate systems. Each station has almost complete redundancy at all levels. Ground station computers send the data to mission computers at SCC for data processing. Important characteristics of ISTRAC network stations are given in Table 3.2.1.

The salient features of the new TTC processor are:

- A compact system which reduces the station size considerably.
- Single receiver built in the processor handles different types of modulations.
- Subcarrier frequency is tunable from 1 KHz to 1 MHz and data rate are also tunable to meet different mission requirement.
- Remote monitoring and control facility.

3.2.5 Functional requirement of TTC network

The functions of the TTC ground stations are:

- Housekeeping data reception in real time mode, dwell mode and play back mode
- SPS/Raw SS data reception and transmission to SSC computers
- Formatting and transmitting the data to SSC computers
- Transmission of commands generated at SCC to spacecraft

1. Operating frequency	
Receive	2200 to 2300 MHz
Transmit	2025 to 2120 MHz
2. Antenna	
Size	10m(1m acq.)
Gain/Temp	19.5 dB/deg K
Velocity	9.0 deg/sec
Acceleration	9.0 deg/sec ²
Tracking mode	
Auto/Program/CDM/manual	
Effective Isotropic Radiative power	> 70 dBw
3. Modulation	
Downlink	PCM/PSK/PM
Uplink	PCM/FSK/FM/PM
4. Timing Accuracy	100 micro secs
5. Transmitter power	2 KW
6. Tracking Accuracy	
Angles	0.1 deg
Range	10,0m
Range rate	0.1 m/sec .
7. Data Transfer	
TCP/IP	

Table 3.2.1 Characteristics of ISTRAC network stations

Tracking the spacecraft and collecting range, doppler and angles data and transmitting to SCC for orbit determination.

The details of various support functions are given in the following sub-sections.

3.2.5.1 Telemetry

ISTRAC ground station(s) receives the down link signals from the spacecraft in real time and perform the following activities:

- Demodulate the signal
- Bit and Frame synchronize
- Time tag
- Format into standard blocks for transmission
- Record analog data for recall

3.2.5.2 Telecommand

Telecommand supports remote commanding in real time during ground station visibility. Commands can also be sent in local mode by entering directly at the SPICE end located at the ground stations and transmitted to the spacecraft.

3.2.5.3 Tracking

Tracking support is provided during any segment of the orbit during the visibility. Tracking support is provided simultaneously with telecommanding. The ground station measures range, range rate(doppler) and antenna angles of the spacecraft. This is essential for spacecraft orbit determination and ephemeris generation.

3.2.5.4 Data communication

Data communication links at ISTRAC establishes the required communication lines in coordination with the national and international agencies, to ensure transfer of telemetry, telecommand and tracking data using standard protocols. The TTC ground stations supporting Cartosat-1 and SSC systems are interlinked continuously through dedicated skylinks using INSAT and INTELSAT satellites and ISDN links as backup.

3.2.6 Spacecraft Control Centre

The spacecraft Control Centre (SCC) located at Bangalore is the nerve center of all TTC and spacecraft control operations. Cartosat-1 mission operations are conducted from SSC which is fully geared up with the necessary technical facilities for carrying out Cartosat-1 spacecraft health monitoring, analysis and control. Mission Analysis Room (MAR), Mission Control Room (MCR) of SSC comprise of several observation consoles and command terminals connected to the computer facility for providing spacecraft health data to mission experts and mission operations team from pre-

launch to end of initial phase. MCR is augmented with an elegant projection system to monitor launch events display and spacecraft ground trace. MAR is large enough to accommodate 18 work stations with improved facilities to cater to the launch and initial phase operations. All mission activities are carried out from Dedicated Mission Control Room (DMCR) of Cartosat-1 in normal phase. SCC has several DMCRs which are restructured to handle many spacecraft missions simultaneously.

The major tasks of SCC are:

- * Scheduling and execution of Cartosat-1 mission operation tasks
- * Planning and execution of orbit and attitude maneuvers as per mission requirements
- * Orbit and attitude determination
- * Scheduling of command operations as part of payload programming
- * Housekeeping data monitoring in real time
- * Spacecraft health data archival and database management
- * Spacecraft health analysis and performance evaluation and reporting
- * Co-ordination with various network stations, IGS, NDC and other related agencies to realize above tasks
- * Anomaly identification and recovery action initiation in case of spacecraft emergencies along with mission experts.

3.2.6.1 Flight dynamics operations

Flight dynamics operations at SCC consists of:

- Processing the tracking data received from ground stations and determining the orbit
- Generations of the orbital events for scheduling and spacecraft operations
- Look angles generation for ground stations.
- Transmission of state vector to the users
- Attitude determination using various sensors data
- Orbit maintenance planning for stringent orbit control

3.2.6.2 Multi-satellite scheduling system

Effective TTC support is allocated to IRS-P6 in the multi-mission environment by ISTRAC Multi-mission Scheduling Software (MSS). MSS software was developed and operationalised at SCC. This MSS interfaces with payload programming system (PPS) in generating the operation schedules and command schedules for IRS-P6 along with other existing missions. MSS generates IRS-P6 schedule optimally by taking into account the following factors in the multi mission operations environment at SCC.

- Spacecraft specific requirements
- Spacecraft operations constraints
- Special operations requirements
- Network ground stations
- Ground stations configurations
- Visibility clashes

3.2.7 Payload Programming

Payload programming is a payload operation scheduling process which comprises of three major modules

- User order processing at NDC.
- Payload schedule generation at NDC
- Command schedule generation at SCC

The payload schedule received at SCC from NDC is scrutinized in the multi-mission operation environment and a confirmed payload schedule is derived in consultation with NDC for this confirmed schedule, command sequence is generated and unlinked to the space craft to cater the needs of payload user community.

ISO 9001 Quality management system is in place at ISTRAC for conducting Cartosat-1 mission operations.

3.3 DATA RECEPTION STATION

3.3.1 Introduction

IRS-P5 (Cartosat-1) is envisaged to support the implementation of satellite based remote sensing for earth resources survey and measurement, mainly for cartographic applications. It has two panchromatic camera payloads with +26 deg and – 5 deg tilted with respect to nadir and to image the area along the track to generate the stereoscopic image of that area.

Cartosat-1 satellite transmits PAN-Fore data and PAN-Aft data at 105 Mbps data rate, QPSK modulated, on two X-band carriers - 8125 MHz and 8300 MHz respectively. The data is compressed and encrypted on-board. Provision exists to selectively enable or disable encryption and compression onboard. In case of Compression by-passed data, only two ports of data per stream with 1/4th the nominal swath is transmitted. Two Solid State Recorders (SSR) with a recording capacity of 120Gb, cater to user requests for regions which are out of visibility of the earth station antenna.

The Primary requisites of data reception station for Cartosat-1 are:

- * Satellite acquisition and tracking facility for S-band and X-band signals.
- * Simultaneous reception of PAN-Fore (PAN-F) and PAN-Aft (PAN-A) data transmitted through two X-band carriers from Cartosat-1 satellite.
- * Real-time data archival and quick look monitoring for the data quality assessment.

3.3.2 Data Acquisition System

The data acquisition system comprises of the following major constituents:

Antenna and Receive Systems :

Tracking pedestal
Servo Control System

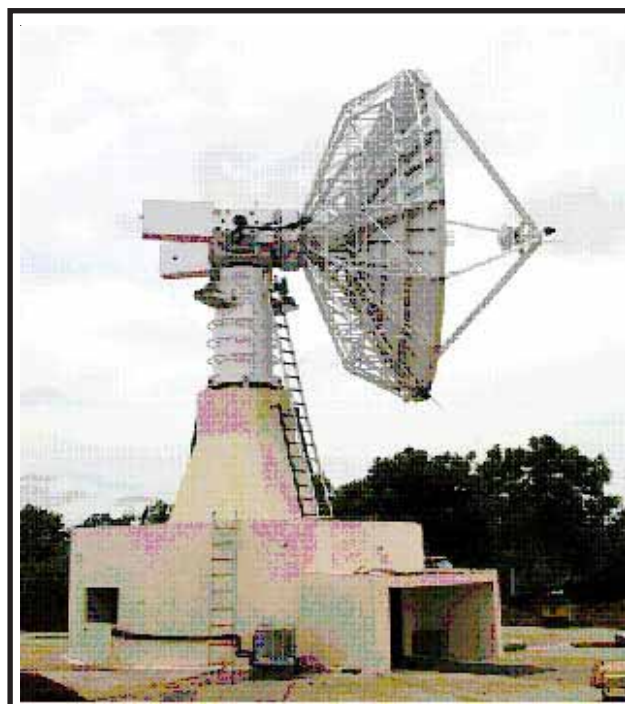

Earth Station Antenna

Receive System

Data Archival and Level-0 Systems :

3.3.3 Antenna and Receive Systems

3.3.3.1 Antenna System

The Antenna system consists of a parabolic reflector of 7.5m diameter and a hyperbolic sub-reflector of 0.736m. The focal length is equal to 3.077m. The reflector surface is made of sixteen single radial stretch formed panels. These panels are made of 1.6mm thick aluminum sheeting and stiffened by aluminum Zee sections (Z section 90 X 32 X 1.6) for all panels. The feed is of composite multi element Monopulse type in Cassegrain configuration, capable of both S and X-band reception.

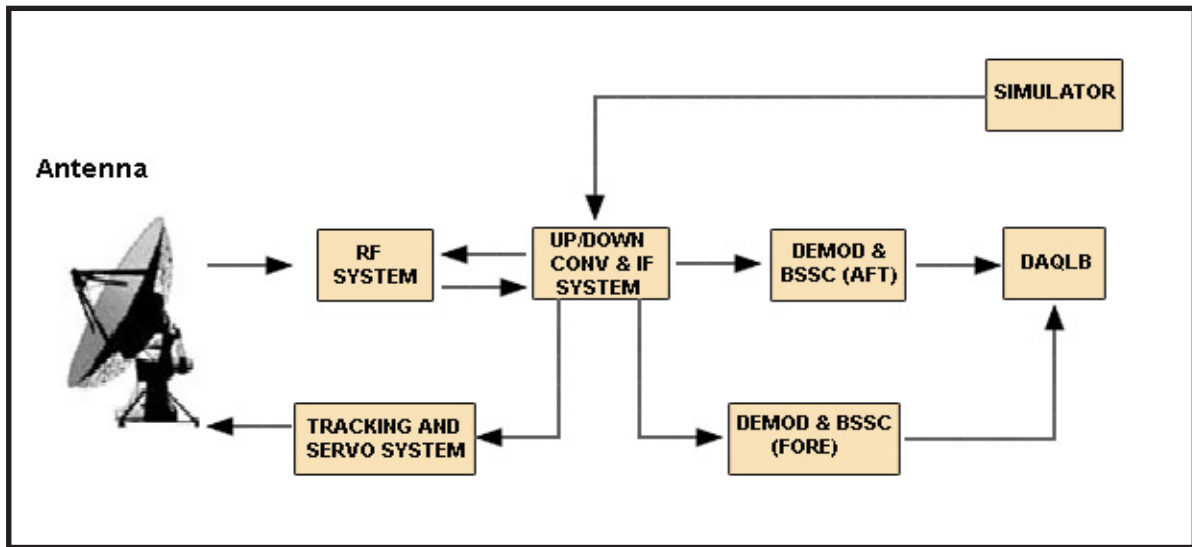

Figure 3.3.1 Block diagram of Cartosat-1 Data Reception System

The tracking pedestal consists of Elevation and Azimuth axes. Each axis is driven by two brushless servomotors, which drive the antenna through reduction gearboxes and slew ring bearings. The electro-mechanical brakes, tachometers, torque couplings, shaft encodes, limit switch assembly, manual hand drives and stow locks are connected at appropriate locations in the drive train of each sections.

Antenna and Tracking Pedestal System specifications :

Antenna type	Fully steerable with EL over AZ
Diameter (main reflector)	7.5 m parabolic solid dish
F/D	0.41
Focal length	3.077 m
Feed type	Cassegrain
Overall Surface RMS accuracy	
(a) Main Dish	0.5 mm
(b) Sub-reflector	0.05 mm
Sky coverage	
(a) Elevation	-5° to 185°

Table 3.2.2 Specifications of Antenna and Tracking Pedestal System

(b) Azimuth Speed	± 360° continuous
(a) Elevation Axis	10° /sec
(b) Azimuth Axis	22° /sec
Angular Acceleration	
(a) Elevation Axis	1° /sec ²
(b) Azimuth Axis	10° /sec ²
Pointing Error	0.08° peak
Temperature	0° C to 55° C
Wind speed	
(a) Operational wind speed	60 km/H
(b) Occasional gusting	80 km/H
(c) Drive to stow	100 km/H
(d) Survival wind speed in Zenith position	200 km/H
Natural Frequency	5 Hz (preferably) but greater than 4Hz.

3.3.3.3 Servo System

The Servo Control System is a type-I/II system with high gain and wide servo band to meet the specifications of high acceleration and precision tracking accuracy. This system can be operated in different modes, which can be selected, from a PC

in remote mode or from the front panel of Servo Loop Electronics Unit (SLEU) in local mode. The automation of tracking operations is implemented in a computer including Program Tracking System (PTS). The PTS software facilitates the automation of the operations. The modes provided in local control are Standby, Manual rate and Auto Track. Brushless DC Servomotors are used to avoid the wear and tear of the brushes. The power amplifiers are IGBT based amplifiers, which generate the DC required for the motor to drive the antenna. The angle is sensed through optical shaft encoders, which are mechanically coupled to the antenna.

Servo System specifications :

Tracking System	Single Channel Monopulse S and X bands auto tracking with PTS as backup
Type of Mount	Elevation over Azimuth
Type of Drive	Dual drive /axis
Pointing error	0.08° peak
Position loop bandwidth	1 Hz
Rate loop band width	2.5 Hz
Tracking accuracy	±0.1° steady state.
*(for EL >88 will be higher)	
Control type	Type – I / II
Angle read out accuracy	0.01°
Safety	Fail-safe electrical / mechanical brakes, Interlocks on stow pins and brakes
Natural frequency	4 Hz
Angle sensor	15 bit Absolute Shaft Encoder.

Table 3.2.2 Specifications of Servo System

3.3.3.4 Receive System

Cartosat-1 satellite transmits PAN-Fore data and PAN-Aft data at 105 Mbps data rate, QPSK modulated, on two X-band carriers - 8125 MHz and 8300 MHz respectively.

The ground station system receives these signals through 7.5 m antenna system consisting of S / X band composite feed. The signals received by the four elements of the feed are processed in Monopulse comparator module to generate three signals namely Sum, ?Azimuth and ?Elevation respectively. The Sum signal is first amplified in Low noise amplifier (LNA) and after necessary signal processing the data (Sum) and the Tracking Error signals are fed to X-band Synthesized down converter for conversion to an IF of 720 MHz and S-band signals to an IF of 70 MHz.

The down converted 720 MHz data IF signals corresponding to PAN-Fore and PAN-Aft carriers are fed to two QPSK demodulator and bit synchronizer sub-systems respectively. These demodulator and bit synchronizer sub-systems extract the PAN-Fore and PAN-Aft payload data. The output data and clock from respective bit synchronizers are fed to real time Data Archival and Quick Look Browse system (DAQLB) for archival and further processing.

The X/S-band tracking IF is applied to tracking receiver to extract the amplitude modulated tracking error information. The EL and AZ DC errors are extracted in tracking controller unit and then fed to servo control system for tracking the satellite.

The S-band telemetry signal at 2245.68 MHz from Cartosat-1 satellite is received and down converted to 70 MHz IF. This IF signal is fed to telemetry receiver for SPS-PB PCM data extraction at 16kbps rate. The time tagged satellite position information derived from this data is used for payload data processing.

Receive system specification :

Configuration	7.5 m high-efficiency dual shaped Cassegrain System
System G/T	
X-band	32dB/°K
S-Band	18 dB/°K
Frequency Range	
X-Band	8.025 - 8.400 GHz
S-Band	2.2 to 2.3 GHz

Type of tracking	Single channel Monopulse
Polarization	
X-Band	RHC
S-Band	RHC
Axial Ratio	1.5 dB maximum
IF frequency	720 MHz
Data rates	
PAN Fore	105Mbps
PAN-Aft	105 Mbps
Carrier frequency	
PAN Fore	8125 MHz
PAN-Aft	8300 MHz

Table 3.2.4 Specifications of Receiving System

3.3.3.5 Cartosat-1 X-Band Link calculations

Frequency	8300 MHz
Modulation	QPSK
Data Rate	105 Mbps (I&Q)
Altitude	617 km
EIRP(PAA)	19 dBw
Elevation angle	5 deg.
Slant range	2799 km
Path loss	178.45 dB
Misc. losses	3 dB
System G/T	31 dB/deg.k
C/No. available	97.15 dBHz
Eb/No. available	17.95 dB
Eb/No. required	12.7dB
System margin	4.25 dB

8300 MHz link calculations (hold good for 8125 MHz also)

3.3.4. Data Archival and Level '0' Systems

The Level-0 Systems perform the critical task of raw data archival, data quality assessment, Ancillary Data Information file (ADIF) generation and Browse data generation. The Level '0' Systems generate the Pass wise FRED SDLTs, ADIF and Browse Files for Payload and SSR data, CAL DLT for CAL passes. The FRED SDLTs and CAL DLTs are dispatched physically and the ADIF and Compressed Browse files are sent through Network.

3.3.3.2 Tracking pedestal

The following operation Modes are supported

RT DAY
 RT + SSR DAY
 SSR NIGHT
 CAL NIGHT

The Level-0 Systems consists of the following sub-systems.

Direct Archival and Quick Look Browse System
 Network Systems
 SPS Direct Archival System
 Timing Systems
 Data Serializer
 Data Path Controller
 Bit Error Rate Test System

3.3.4.1. Direct Archival and Quick Look Browse (DAQLB) System

The DAQLB system consists of LINUX based PC server with Internal RAID for raw data archival, PCI ULTRA SCSI interface for AFEH and Super Digital Linear Tape (SDLT) drives, AFEH units (2 Nos.) and Time Code Translator as shown in the Figure 3.3.2.

The data and clock from BSSC in real-time along with IRIG-A parallel BCD time code is fed to Advanced FEH units (AFEH-1 and AFEH-2) through Data Path Controller (DPC). These AFEH units are connected to DAQLB through Ultra SCSI interface. AFEH does frame synchronization and word synchronization on the incoming payload data and transfers the raw data to RAID system connected to DAQLB in real-time. During real-time for payload passes, the AFEH provide raw data along with GRT to DA System through Ultra SCSI Interfaces, for both the streams.

The DAQLD module of Level-'0' software does raw data archival of the Compressed/Encrypted/RS Encoded data of both sensors on internal RAID. It also provides the real-time display of sub-sampled,

decompressed and decrypted data for both sensors (selected channel). The AUX extract module creates the sensor wise auxiliary data files extracting the relevant words from the raw data files. The MOVIES software does the telemetry master frame construction and validation. These modules operate for all the RT, SSR and CAL passes. The Decode/ Decrypt module does the Data RS Decoding and Decryption. The Decompression module performs the decompression of the compressed payload data archived in real-time. The AuxAlign software does the alignment of the aux data with decompressed video data. The SVD EXT module creates the pass/ segment wise sub-sampled video data files for both sensors, which are subsequently used for Browse generation. Both modules operate in Near Real-time mode.

The state vectors received from SCC, SPS data received in L-Mode and G-Mode are used for generation of ephemeris and orbital information. The SPS L-Mode data is received in LBT chain and the G-Mode data is received in S-Band Chain. Attitude determination is done with constructed telemetry frames using attitude Sensor data. This information

along with ancillary information including data quality, line count is used for generation of ADIF. Compressed Browse Images are generated from Raw Browse data and transferred on Network to Browse Archival System at Balanagar. ADIF is also transferred to IMS over network. FRED format SDLT is generated for both payloads and sent as final product.

Night pass operations include CAL and SSR PB. For CAL passes, on-board calibration data is archived and the CAL pattern is displayed in real-time. The DAQLB system extracts auxiliary data and Telemetry master frames are constructed, selected cycles calibration disk load is carried out and CAL DLT is generated and dispatched to DQE. For SSR-PB, raw data archival, quick look display, extraction of auxiliary data, OBT-GRT correlation, telemetry master frame extraction, ADIF generation, Browse generation and transfer over network and FRED Formatted SDLT generation are the activities carried out.

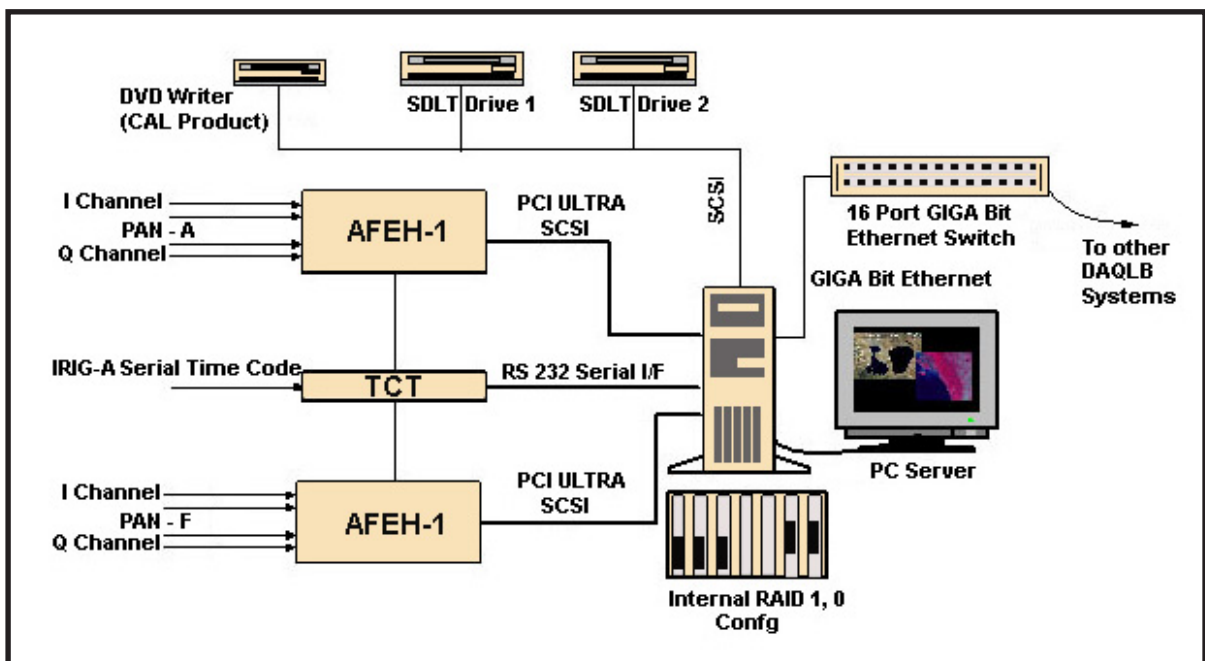

Figure 3.3.2 Level-0 DAQLB System

3.3.5 Network System

(A) Level-'0' Intranet

The Level – 0 DAQLB Systems, PC based Direct Archival Systems and the Octane O₂ systems are all interconnected through a Network Backbone consisting of Switches, routers and hub. All the PC based DAQLB Systems are connected to the existing Back Bone system through a 100 Base T port of the 10/100/1000 Base T Ethernet Switch.

(B) Data Transfers and Spacenet Interfaces

Level-'0' System's interaction on Spacenet

With SCC:

- * S-Band and SPS State Vectors
- * Attitude Biases
- * Pass Information Files
- * Pass Schedules

With DQE, IMS and NDC:

- * ADIF for PAN-A and PAN-F to IMS
- * Browse for PAN-A and PAN-F for RT and SSR to Browse Archival System to NDC.
- * Scene wise raw data for urgent products generation to support disaster management.
- * CAL Analysis Data to DQE

(C) Software for Network Transfers

The Level '0' products like ADIF and Browse for all IRS missions are transferred to the NRSA Data Center at Balanagar via Spacenet. The files are first transferred from individual DAQLB workstations to the Network Server. These files are then transferred to the Browse and Accession Database servers and

archived. All these events happen for every sensor/mission asynchronously and it is highly laborious to do it manually. Therefore Network monitoring utilities are developed to handle the above transfers, to check the status of network, disk space availability at NDC server end and file transfer status. Software also logs the transfer status into the database for reference and report generation in auto mode.

(D) Level '0' Information System

Level '0' Information System is a server based web enabled program, which provides a database for all Level '0' operations for the mission on a daily basis. The program is developed around Client/Server environment. The Server program contains the basic logic for database management. The Client side program caters to the pre-processing of user inputs before uploading to Server. This reduces the load on Server and also the right information is also updated. A shell script program is developed to post-process the ADIF information to extract AOS, LOS, Data On/Off, other relevant pass information, data quality etc.,. The script generates an interface file that is used by the Server program as base data for the given date of operation. This software has been augmented with utilities such as monthly and weekly progress reports, sorting based on problems, etc. Automatic system generated Level'0' reports on daily basis is a novel concept to provide non-subjective, error free and dependable report for satellite control team at ISTRAC, for mission management team at ISAC, data processing team at NRSA, SAC and other decision makers.

(E) Backup Management System

The Level '0' systems handle the image data and the mission parameters. The mission parameters need to be managed for mission life for every satellite. Hence the backup management is one of the important and critical tasks of real time systems.

The data from these operational files are required for future reference for ADIF regeneration, mission analysis, product/software problem analysis etc.,. The Level '0' product for any IRS mission contains, apart from raw data in FRED format, auxiliary data, orbit information, attitude data, browse data, data quality information and ancillary data information for every sensor of the respective satellite. Therefore, the above data is backed up on a daily basis after the Level'0' product is generated for every sensor. Day wise incremental backup is taken up from disk to RAID. After one week of backup on RAID, the data are transcribed onto DLT media for permanent storage. Hence on any day, previous one-week data is readily available on RAID disk for immediate usage. In real time systems, system backup management is mandatory to maintain high system availability and hence system backups are taken at regular intervals.

3.3.6 S-Band SPS Direct Archival System

The system, developed in-house, is operational for acquiring the SPS data available in S-band chain at 16 Kbps data rate. The raw data are ingested in real-time to system disk. The format of raw file is compatible to SANGAM software requirement. The features of the system are:

- Hardware designed in FPGA
- It has programmable
 - Word length counter
 - line length counter
 - frame sync code & length
- Maximum buffer Length is of the order of 12KB size per line
- Raw data file format is as per SANGAM software requirement
- Real-time display of selected parameters
- The archived data transfer over network to DAQLB system

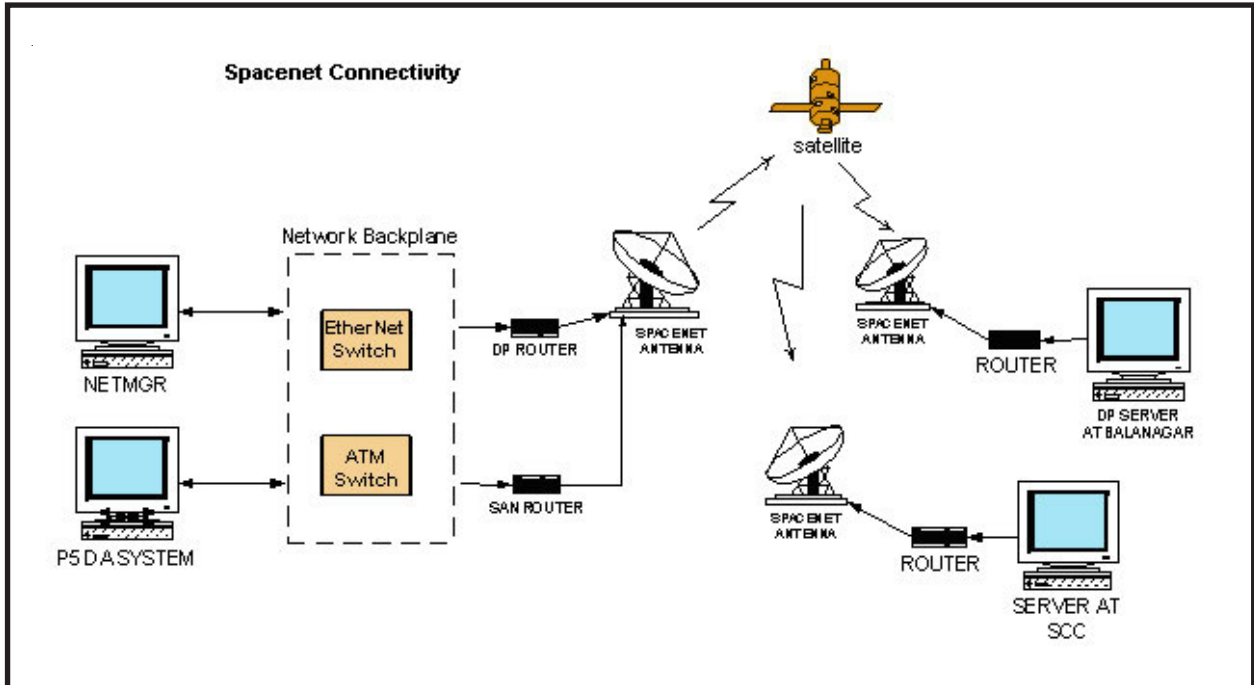

Figure 3.3.3 Level-0 Network Connectivity

3.3.7 Timing Systems

Timing facility is one of the critical elements of the data acquisition and level-0 processing system. Ground station and real-time data archival system works on UTC. UTC is used for satellite pass scheduling and as a reference for the received satellite data.

The station time is maintained precisely with respect to universal time using Global Positioning System (GPS) Receiver. This is achieved by means of Time Code Generator (TCG), which is driven by high stability oscillator. The TCG gets synchronized to the GPS time everyday, and generates IRIG-A time with accuracy better than few microseconds.

The TCG output is distributed to Time Code Translator (TCT) units connected DAQLB system via serial time distribution unit. TCT units provide parallel BCD output that is extended to Advanced Front End Hardware (AFEH) units. Satellite payload data logged into DAQLB system is tagged with UTC by AFEH unit. DAQLB system time setting is done by reading UTC from TCT, through RS-232 interface.

3.3.8 Data Serializer System

Data Serializer System (DSS) is a PC based system to serialize data at high speeds for the purpose of reception chain testing and for Level-0 processing evaluation. Data available in a file is serialized into synchronous serial format. The system consists of a Pentium-IV PC with a high-speed PCI parallel data acquisition card, RAID0 (140GB capacity) and an add-on serializer unit. The data provided on DLT media is first copied onto RAID. Cartosat-1 simulation data for both PAN-A and PAN-F sensors is interleaved and written as a single file onto the RAID. This enables stream synchronization while serializing data. Data on RAID is transferred to the external serializer unit via PCI data acquisition interface card. The serializer hardware can serialize incoming parallel data into two or four synchronous streams. The block diagram of DSS is shown in figure 3.3.6.

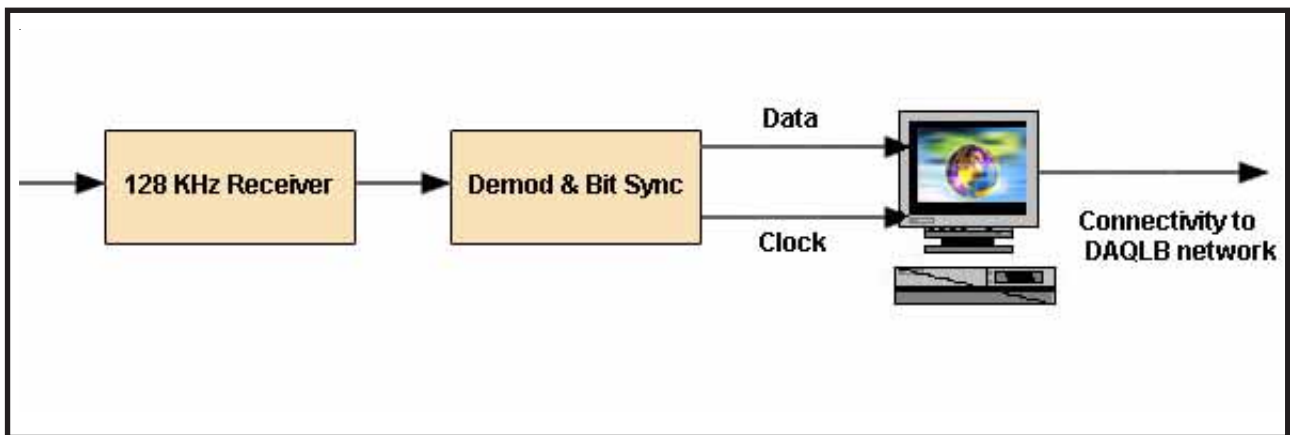

Figure 3.3.5 SPS Direct Archival System

DSS Specifications :

Output streams	4 (maximum)
Output logic	ECL-SE System
Output impedance	50 ohm (unterminated)

which any of the input channel (data-clock pair) can be connected to any of the output channels or any input can be extended to any number of output channels up to 16 outputs, thereby providing 256 switching combinations.

3.3.9 Data Path Controller

Data Path Controller (DPC) is a 'high-speed switching matrix', which aids in quick and automated connectivity between 'bit synchronizer' units, data serializer system and AFEH units. The unit can accept up to 16 ECL-single-ended data-clock signal pairs and route them to up 16 output channels. DPC contains high-speed switching matrix modules with

DPC can be configured manually through a keypad, or through remote control via optional IEEE-488 interface. The configuration information is displayed on the front panel graphics LCD display. This unit is a stand-alone system with built in power supply. The input/output signals are connected to BNC connectors mounted on the rear panel of the unit.

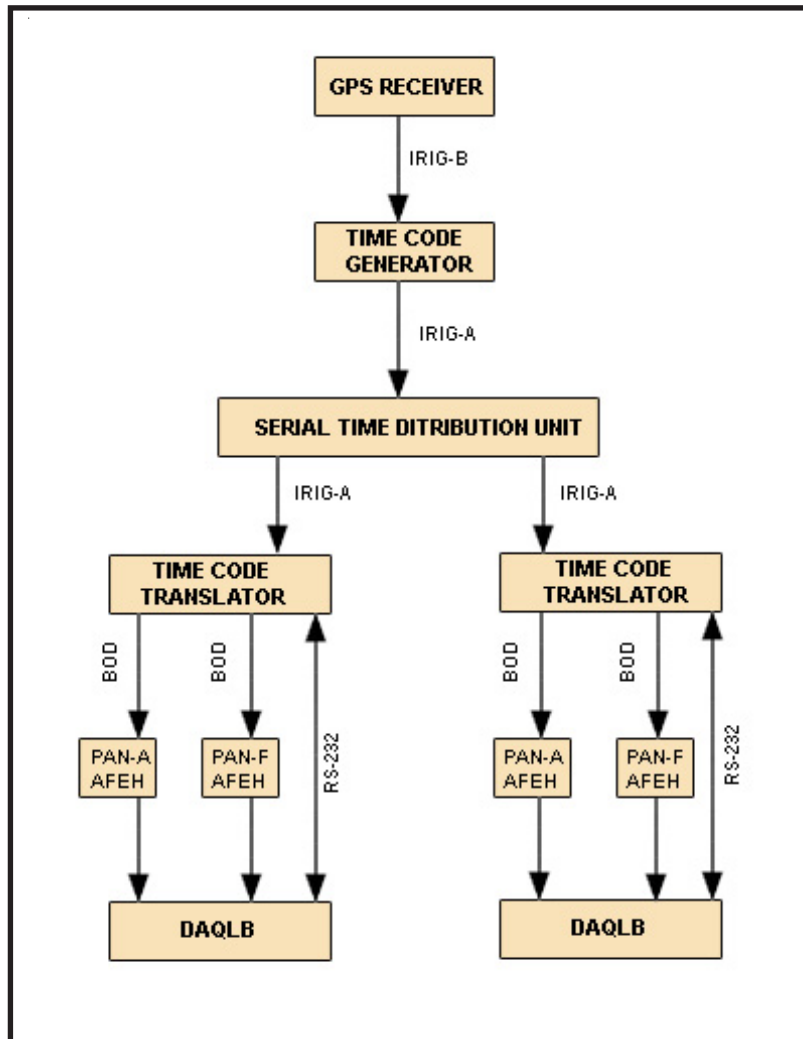

Figure 3.3.5 Timing system block diagram

DPC Specifications :

Input Channels	16 data-clock sets
Output Channels	16 data-clock sets
I/O Logic	ECL Single Ended
Max Data Rate	180 Mbps
Input Power	230 V $\pm 5\%$ @
50Hz ± 2 Hz	
Connectivity	one-to-one, one-to-many (total 256 combinations)
User interfaces	Keypad, IEEE-488

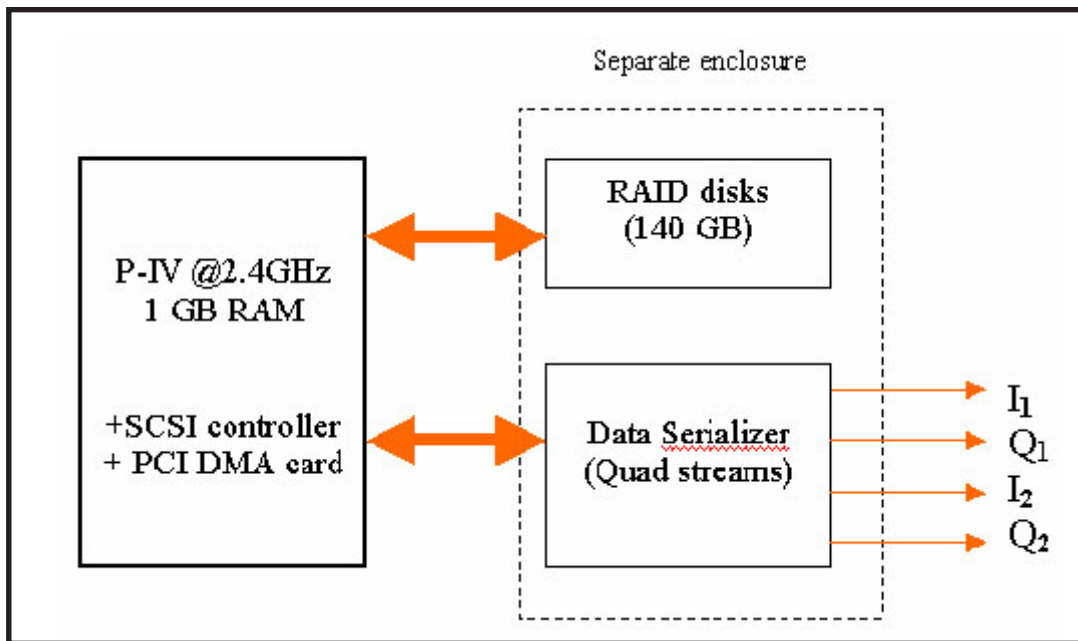

Figure 3.3.6 Block diagram of Data Serializer System

3.4 DATA PRODUCTS GENERATION FACILITY

Cartosat-1 Data processing system facilitates generation of various types of data products in digital and photographic formats as per user requirements. A catalogue of all the data acquired, along with cloud cover, quality information is prepared and maintained in an Integrated Information Management system (IIMS) for easy retrieval.

A new data processing system, exclusively for generation of Cartosat-1 data products has been established. This facility consists of two servers for generation of DEM and TCPs for the data acquired and one server for generation of data products. This facility also contains one data storage server to archive TCPs and DEM generated using Stereo Strip triangulation System (SSTS). The outputs of SSTS are used by DPS to generate ortho-corrected products. The TCPs archived are also used by other systems at NRSA for generation of value added products.

Stereo Strip Triangulation System (SSTS) :

Stereo Strip Triangulation System (SSTS) carries out strip triangulation for the acquired cloud free data to provide high precision georeference products. It is an unique and complex software system capable of handling large size satellite data in raster format with user friendly Graphical User Interface (GUI)

The raw imagery cannot be utilized directly for SST processing as it suffers from radiometric, geometric distortions and need to be corrected. Radiometric distortions can be eliminated using mathematical algorithms that utilize the information pertaining to the imaging characteristic of camera/sensor. Geometric distortions can be eliminated by applying mathematical formulae on the ground points that relate these points to the corresponding image points in the satellite image.

For more precise geometric correction, the satellite orientation parameters need to be refined for

overcoming the errors. This is achieved using Ground Control Points. A Ground Control Point (GCP) is a permanent point on the earth's surface whose position is precisely known. Using ground coordinates of GCPs and their positions on the image, satellite orientation parameters are refined using mathematical algorithms.

Establishment of GCPs based on actual ground survey is tedious and time consuming. So there is a need to establish a network of dense control points on the ground that have similar characteristics as GCPs.

The methodology that uses GCPs and Stereo image pair to derive secondary control points is known as Stereo Strip Triangulation and the secondary control points are known as Triangulated Control Points (TCPs).

SSTS has a mix of interactive and automatic computing components and enunciates a balancing of I/O intensive and computation intensive activities.

The primary objectives of SSTS are

1. To create a library of Triangulated Control Points (i.e. TCPs) for the entire country in Stereo mode, so that any smallest satellite image data set can be generated with high location accuracy
2. To construct coarse Digital Elevation Models (DEM)
3. Reconstruction (refinement) of satellite orientation parameters

Data processing system :

Cartosat-1 Data Products Generation System is a software package to generate Remote Sensing Data Products for Cartosat -1. Using this software the operator can ingest data products requested by NDC

and generate them in the user specified output format and media. The generated user data products are dispatched to the next work centers viz. Data Quality Evaluation, Data quality checking, Special Product generation and Photo writing.

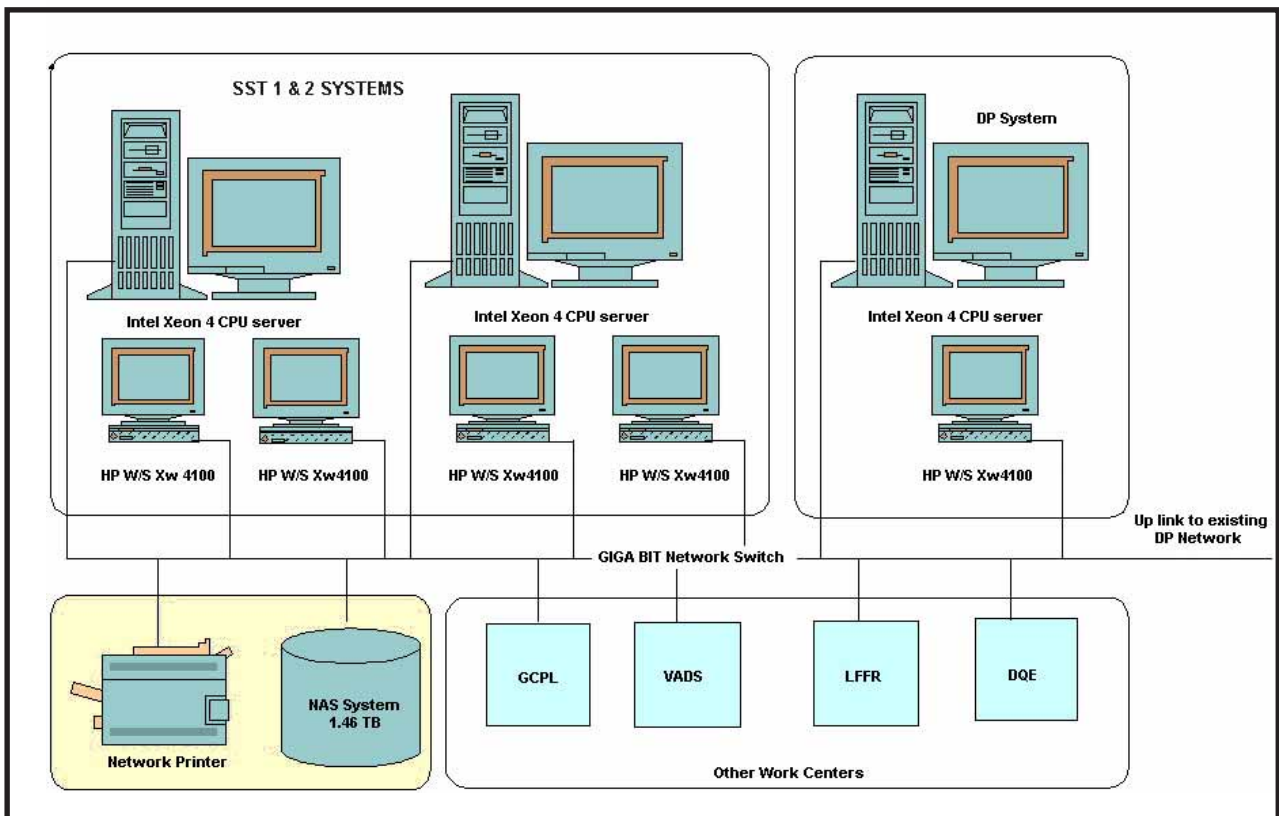

Figure 3.4.1 Cartosat-1 Data Processing System block diagram

3.5 IMAGING (FILMING) SYSTEMS

The Imaging system consists of Large Format FotoRite (LFFR) and Small Format FotoRite (SFFR). It facilitates generation of B/W and Color Photo products. The Photographic prints up to 40" x 40" size are generated with different scales as per the user requirement. The LFFR is the main chain and the SFFR is the back up chain of Photo products generation.

3.5.1 Large Format FotoRite (LFFR)

LFFR is a high precision digital photo writing system with a unique capability of supporting direct writing on B/w and Color photographic paper. It can accommodate up to 20000 x 20000 pixels to facilitate generation of Large scale prints up to 1000mm x 1000mm size. Recording of the digital image on photographic paper is facilitated by exposing at an individual pixel level which ensures high MTF and sharp images. Image quality and throughput are better in comparison to the conventional method of optical enlargements made from master films negatives.

Linear gamma Look Up Tables (LUT) are used for correcting non-linearity of photographic paper, Photo processing and Photorite characteristics.

Main activities :

1. Ingest of input data through network file transfer as per priority assigned in the IMS work order.
2. Interactive scene based Enhancement of digital data.
3. Grid and annotation overlay, Map composition for precision and special products (Figure 3.5.1)
4. Periodic calibration of the unit and working out Linear Gamma LUT.
5. Generation of photo products.

3.5.2 Small Format Fotorite (SFFR)

The Small Format FotoRite (SFFR) is the backup chain for photo products generation. It is capable of generating B/w and Color film negatives of 10" x 10" size. The digital data is exposed on a film negative. The prints are generated using conventional optical enlargers at Photo Processing Facility.

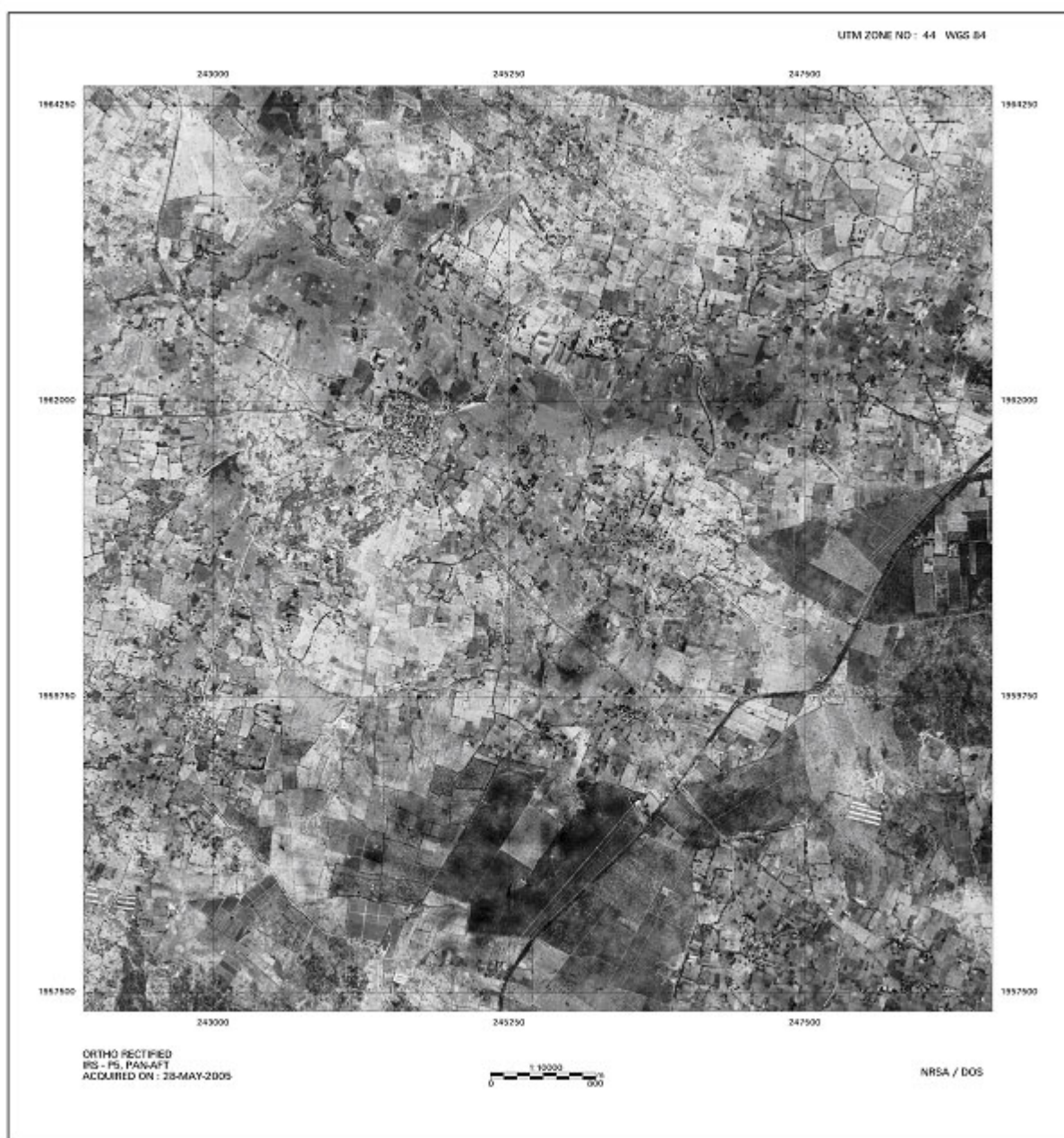

Figure 3.5.1 Photo product template for Precision products

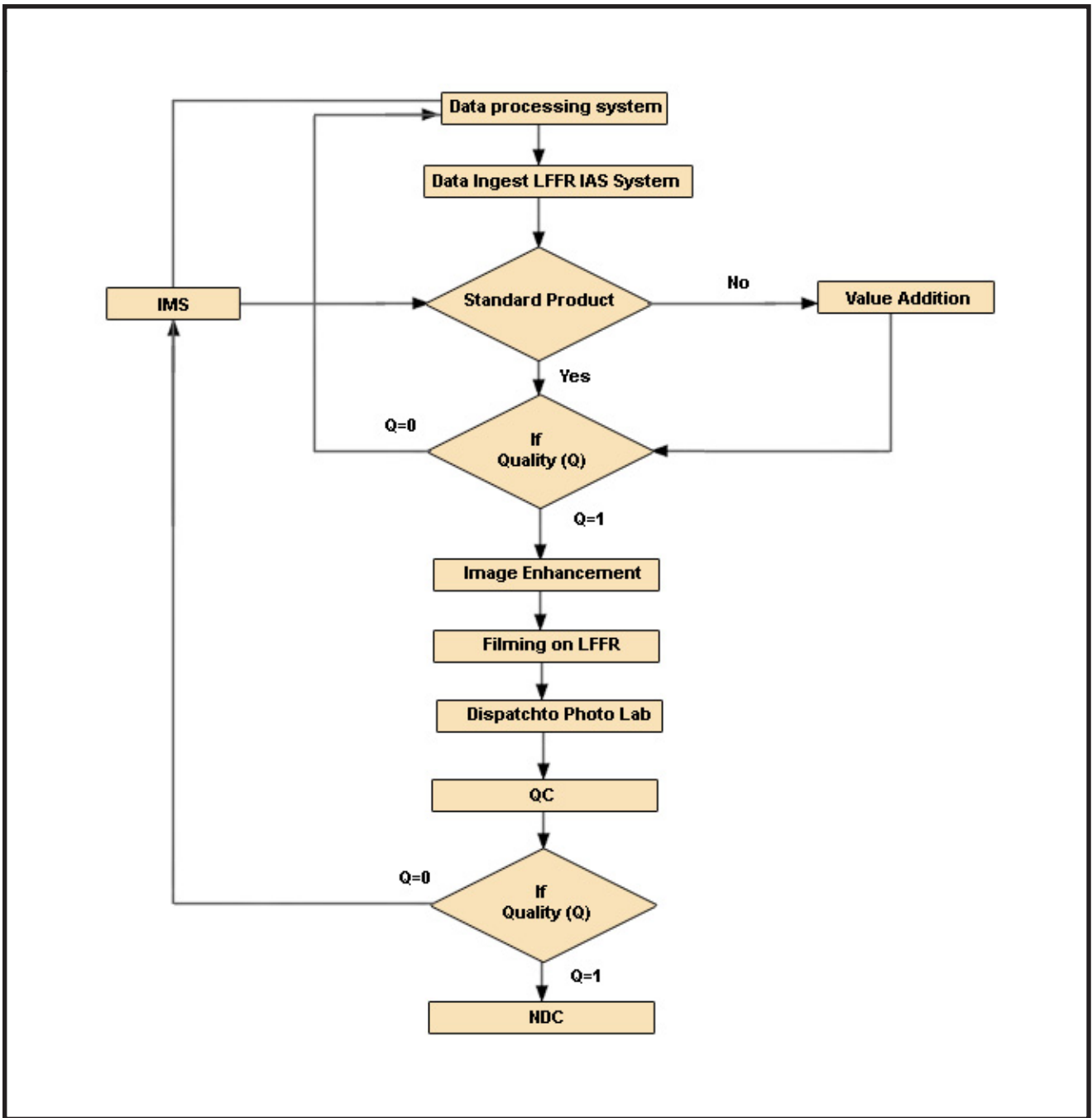

Figure 3.5.3 Imaging process flow chart

3.6 PHOTO PRODUCTS GENERATION SYSTEM

Photo Processing Facility is responsible for processing of B/W prints from LFFR and master films from SFFR systems and also generation of all B/W photo products in the form of B/W prints. Photo Processing Facility is equipped with modern photo processing and printing systems. The facility is tailor-made to meet the stringent turn around time and quality requirements of satellite photo products as required by users. The facility is equipped with the following major systems

- * B/W paper processors
- * B/W film processors
- * Contact Printers and Auto Focus Enlargers
- * QA and QC systems
- * Sensitometric lab
- * Chemical analysis lab

Exposed B/W papers and films are processed in the B/W paper and film processors respectively. Processed papers and master films are sent for quality check to Quality Control Work Centre. The film products which qualify the quality criteria are routed to photolab for further printing. Photolab

generates work orders from Integrated Information Management System (IIMS) for LFFR and SFFR photo products and draws the required masters from film archives and generates the photo products as per the job order. The final products are sent for quality check to quality control work centre. Photo processing facility has a number of in-built in-process-control checks to ensure generation and supply of quality photo products. To support the product generation activities sensitometric and analytical support facilities are also available. In view of the latest laser printing technology adopted by NRSA, most of the products are generated in LFFR (main mode) and processed at the photo processing facility while SFFR mode of product generation is limited to backup mode.

The functions of various photographic systems used for photo products generation are given in Table 3.6.1.

Name of the system	Function
<p>Main Mode (LFFR)</p>	
<p>Colenta B/W paper processor Quality Assurance systems</p>	<p>Processing of LFFR B/W paper prints In-Process-Control and Pre-Qc</p>
<p>Backup Mode (SFFR)</p>	
<p>Versamat film processors DURST/HK Enlargers Hostert / Colenta B/W paper processors Quality Assurance systems</p>	<p>B/W film processing B/W Enlargements B/W paper processing In-Process-Control and Pre-Qc</p>

Table 3.6.1 photographic equipments and functions

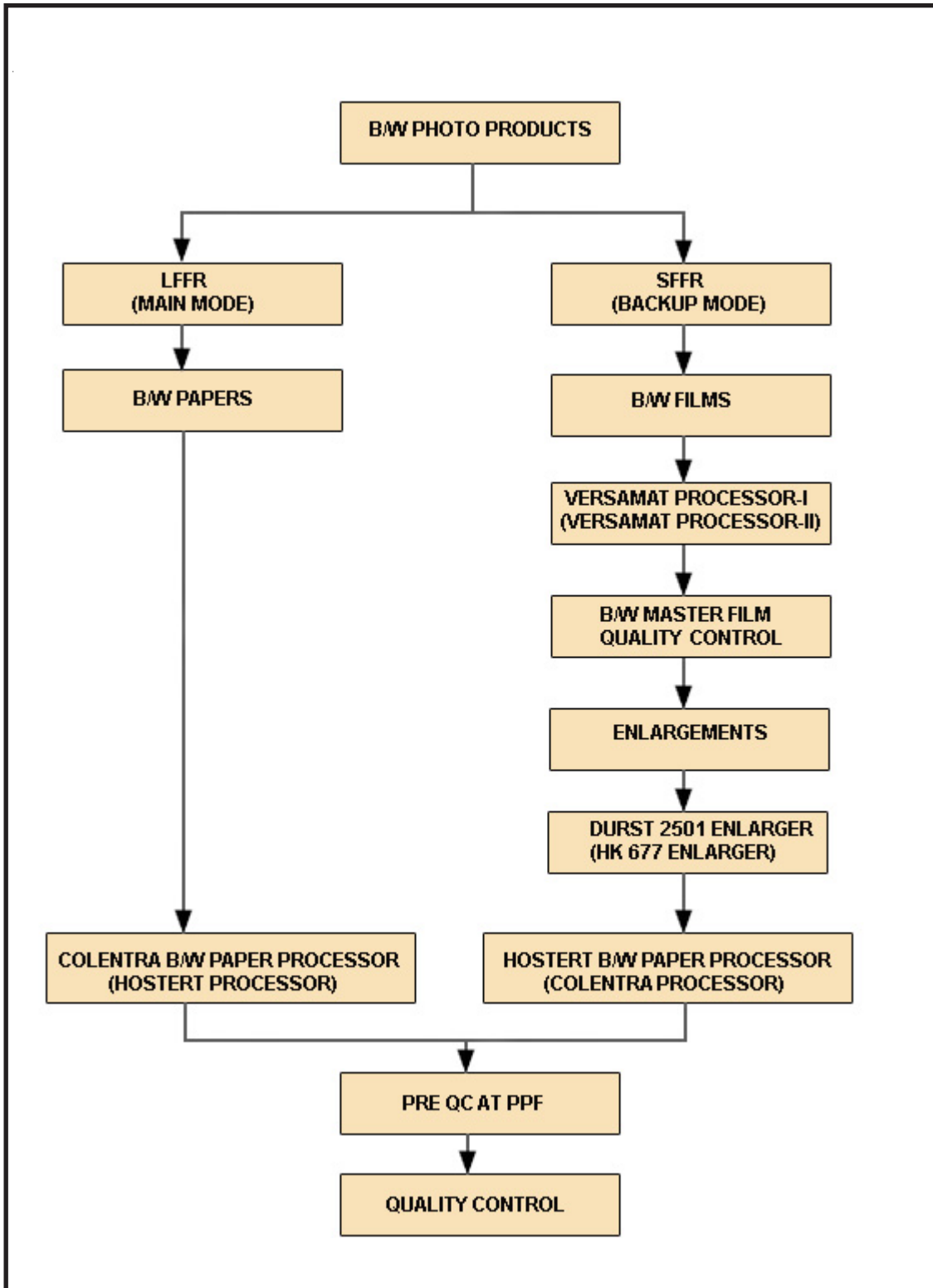

Figure 3.6.2 Photo products generation flow

3.7 QUALITY ASSURANCE

It is ensured that only good quality data products are sent to the users. Both digital and photographic data products are checked for a set of pre-defined quality criteria prior to supply to the users. The photo products are inspected for data processing and filming / photo processing problems.

3.7.1 General criteria

- * Products should be free from severe vertical striping
- * Scattered pixel drop out should not affect more than 5% of the total image area
- * Data loss should not exceed one scan line
- * There should not be any image distortion affecting the continuity of data
- * Data should be free from noise related artifacts.
- * Geometric quality should be as per the specifications

3.7.2 Photo products criteria

By default, all B/W and color photo products are generated in Large Format Fotorite System (LFFS) and the Small Format Filming System (SFFS) is

Parameter	B/W	FCC
D Max	1.75 ± 0.10D	0.90 ± 0.10D
D.Min	<0.20	0.25R, 0.65G, 0.85B
Colour Balance	- <0.07D at 0.60D	above B+F
Linearity of grey scale	=6% of D Max	<8% of D Max
Density Uniformity	=0.08D at 0.80D above B+F	<0.05 at 0.6D above B+F
MTF	<75% at 17 cycles/mm	<60% at 17 cycles/mm
Physical Dimension	<0.1%	<0.1%

Table 3.7.1 Specifications of Photographic masters

used as a backup chain. Specifications of the photo product masters generated in backup mode are provided in Table 3.7.1. All the photo products are visually inspected and graded as accepted and rejected. The rejected products, depending upon the type of problem, are put back to either DPS for regeneration or to filming for refilming or to NDC for an alternate date. All photo products should conform to the following criteria.

- * Film Recorder problems such as micro banding, seating problem, recorder lines, fog, scratches etc., should not affect the interpretability of the image and aesthetic quality of the image.
- * Photo processing defects such as roller marks, scratches, fog, dust, finger prints etc., should not affect the interpretability and aesthetic quality of the image.
- * There should be sufficient image contrast and density so that the photographic products can be interpreted easily.

Parameter	B/W	FCC
Dmax	≥ 1.90	≥ 2.30
Dmin	≤ 0.15	≤ 0.15
Colour Balance	—	≤ 0.1D at 1.0 D
Physical dimension	≤ 0.15%	≤ 0.15%

Table 3.7.2 Specification of photo prints (Products)

3.7.3 Digital product criteria

- * Digital products checking goes through the following sequence :Digital products should be free from physical damage and be readable in a system other than the one available in the production unit.
- * Conform to radiometric and geometric quality specifications

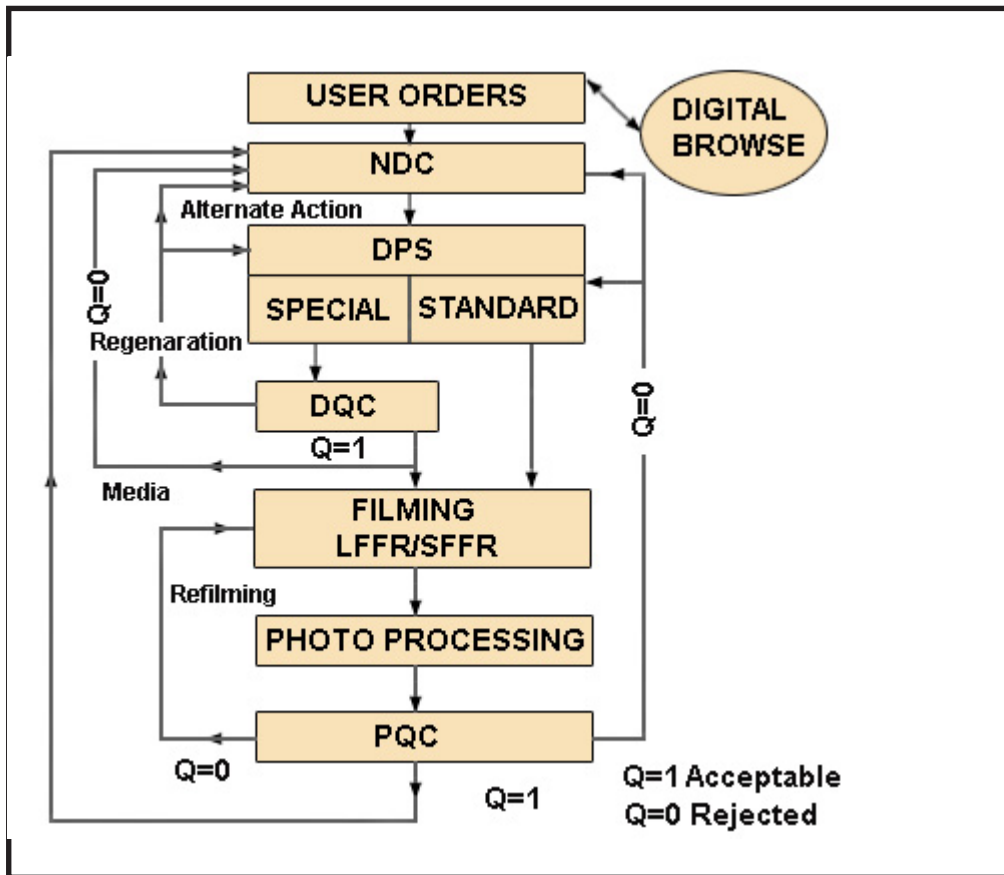

Figure 3.7.1 Flow Chart for Generation of Photo Products

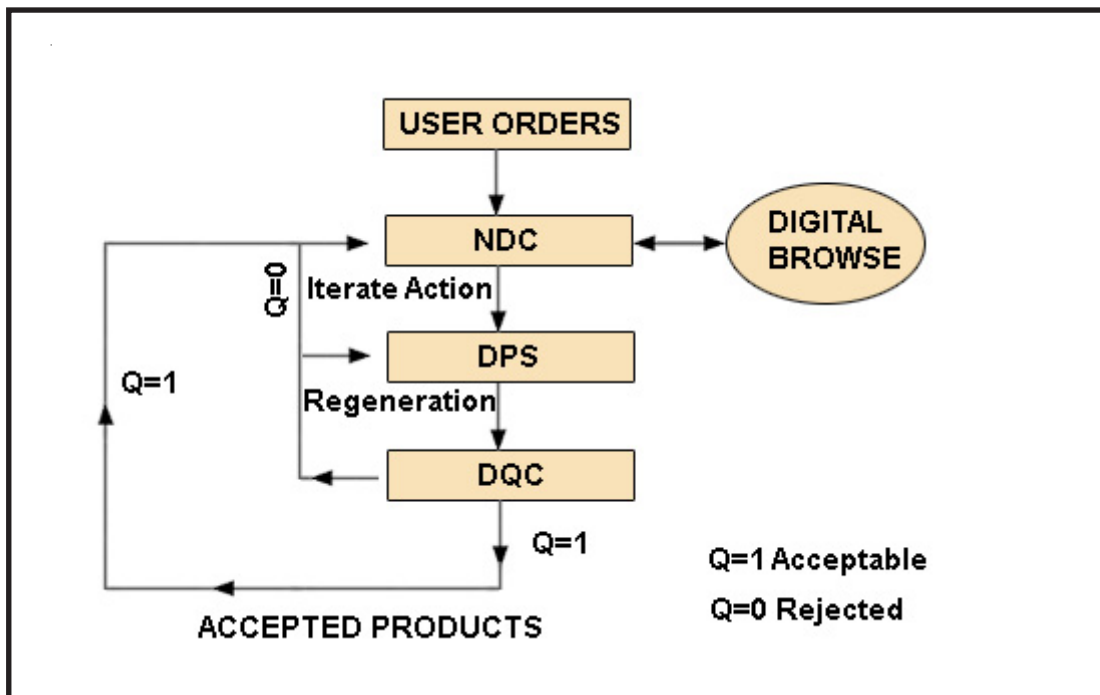

Figure 3.7.2 Flow chart for Generation of Standard and Ortho digital products

- * Digital product should conform to NRSA digital product format document.

The flow chart for generation of digital products is given in Figure 3.7.2

Apart from the above, the following checks are performed for different types of products.

Stereo :

- * Ensure a minimum of 60% overlap between the two scenes.
- * Verification of co-ordinates of products with IMS details.
- * Verification of restricted area masking.

Ortho kit :

- * Conformation of co-ordinates with meta file information.
- * Verification of RPC file information.
- * Verification of restricted area masking

Ortho corrected :

- * Verification of product co-ordinates with meta file information.
- * Verification of restricted area masking.

AOI based products :

- * Verification of sidelap and overlap.
- * Verification with the shape file for area coverage
- * Verification of product co-ordinates with meta file information.
- * Verification of restricted area masking

Geometric accuracy for Standard and Precision (Ortho) products are given in Table 3.7.2 and Table 3.7.3 respectively.

3.7.4 Geometric Data Quality Control (GDQC)

Appropriate checks are made to ensure the location accuracy of the digital products. Geometric accuracies are verified at the time of generation by PGS and the accuracy certificate to this effect is issued along with each product to QC. The products matching with theoretical values are accepted and supplied to the users. The certificates are retained at QC.

3.7.5 Screening and validation of sensitive areas / masking

As per the guide lines provided by the Ministry of Defense, India, sensitive areas in all products with 5m and better than 5m resolution are masked before supplying to the users. Some extra area masking is done as appropriate, to account for the location accuracy. All products are validated for sensitive area masking at QC and certified before dispatch to users. The data with improper masking is put back to DPS for corrective action.

3.8 DATA QUALITY EVALUATION

Objectives of the Data Quality Evaluation (DQE) system are

1. To characterize end user product performance with respect to Cartosat-1 mission specifications
2. To monitor the sensor performance regularly through mission specific DQE parameters

This system measures and quantifies the systematic and random variations in payload and platform performance. The systematic performance is adjusted as system bias in the Ancillary Data Information File (ADIF). The uncertainty in the performances has an impact on the accuracy of the final user product and results in deviation from mission specification.

The DQE system generates regular performance evaluation reports as feedback to mission for corrective action. These reports are stored in

ORACLE Database, which depicts statistical trend of product accuracy achieved during mission period.

The various DQE parameters related to payload, platform and user product performance, are classified into radiometric parameters and geometric parameters. The engineering performance of the detector port and detector array behavior is quantified from sample Histogram of acquired raw data and in-flight LED based exposure scheme of Onboard Calibration System in near real time.

Scene based radiometric parameters are evaluated from Basic Stereo Pair and geo-location accuracy, scale, local variation and standard deviation are estimated on system corrected products. Reference images (location accuracy better than 50m) and precise Ground Control Point Library (better than 5m) are used as reference for location accuracy estimation during product evaluation.

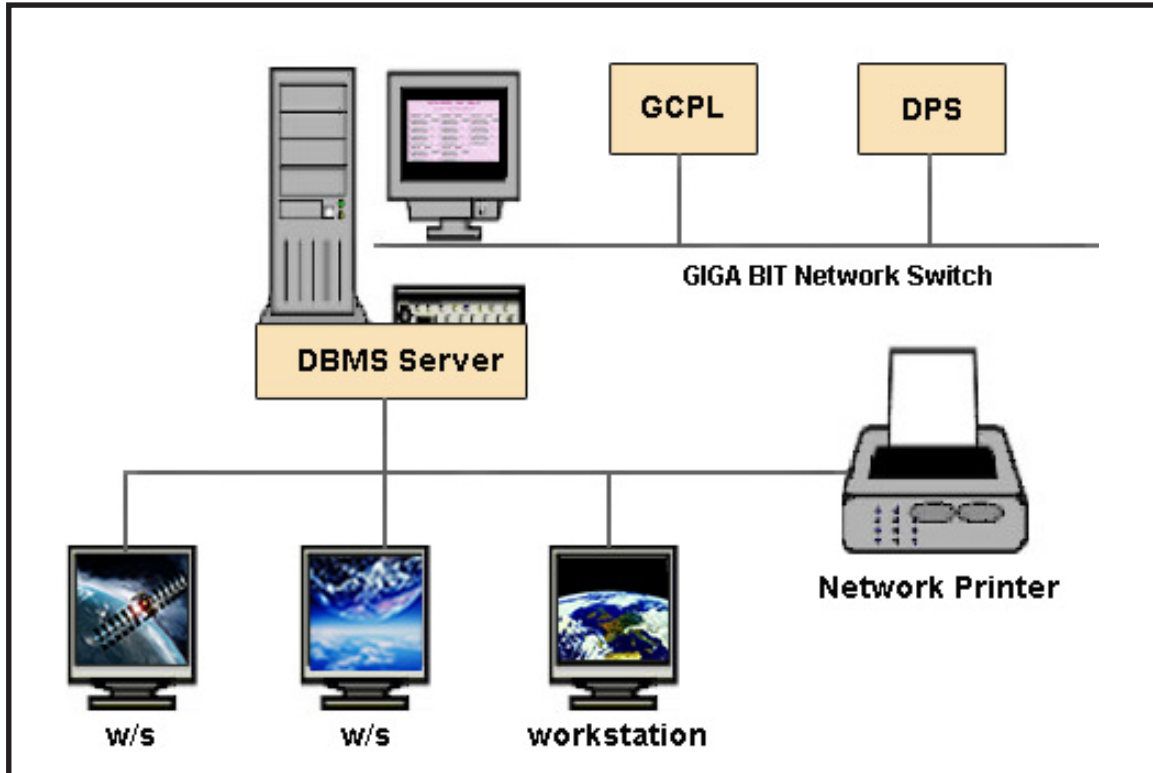

Figure: 3.8.1 DQE Activity Flow Diagram

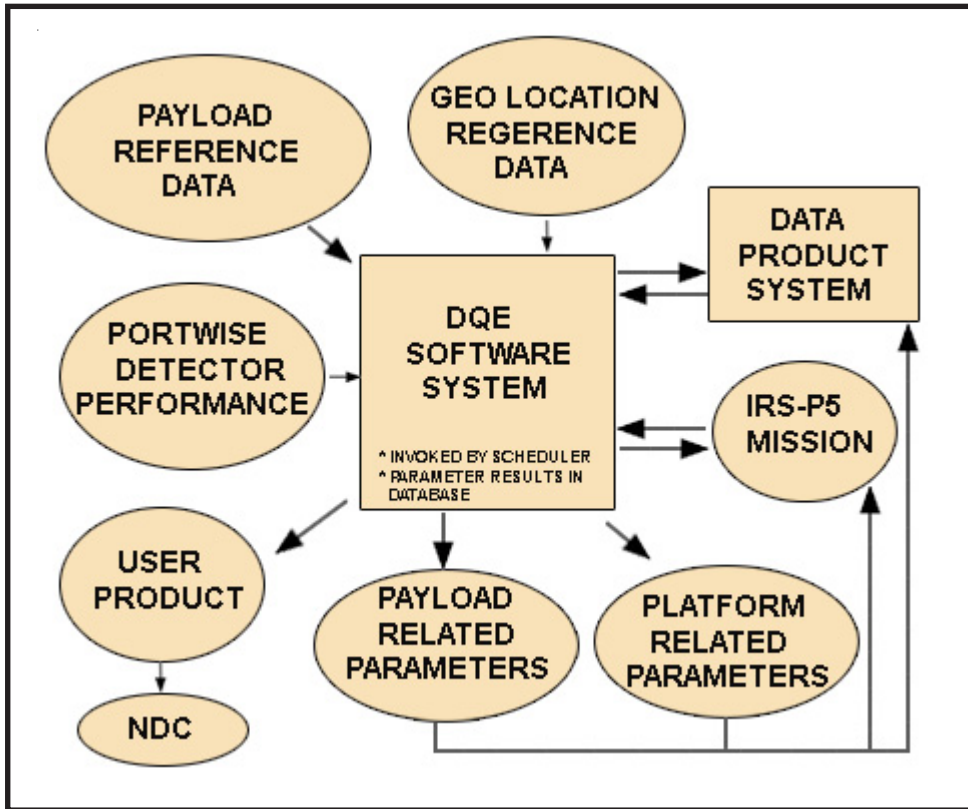

Figure 3.8.2 DQE S/W System

In Ortho Image, terrain specific corrections are carried out in DPS using DEM generated from basic stereo pair geometry. DQE activity flow diagram and scheduler driven Cartosat-1 DQE software System for routine operations, are given in Figure 3.81 and 3.82.

Mission related geometric parameters like user product swath and resolution in various payload operations modes, variation of scenes overlap / sidelap with time are also monitored from raw and system level corrected products.

3.9 Integrated Information Management System

The integrated Information Management System (IIMS) is a management tool for controlling the work flow of the data processing activity. It automates the total production chain right from the work order generation till the despatch and invoiceing of the products generated. It is an integrated system handling the entire satellite data product generation. IIMS manages the accession information of all the satellites.

IIMS system is built around UNIX servers. The configuration of the IIMS system is given in Figure 3.9.1.

The main functions of IIMS are :

- * Management of the acquired data
- * Generation of accession catalogue
- * Proforma processing
- * User order / request processing
- * Priority of data products generation
- * User accounting / billing management
- * Various reports for monitoring the production status of the products
- * Dynamic scheduling of data requests to a system
- * Updation functions for each work center
- * SDLT / films archives management

- * Production management
- * Accounting in Indian and Foreign currency
- * Statistics on data usage by users

Various work centers involved in the production chain are :

- * NRSA Data Center
- * Data Processing Systems
- * Special Products Generation System
- * Filming System
- * Photo Processing Facility
- * Photolab
- * Quality Control
- * DQE System
- * ADIF Regeneration System
- * Archives

The work centers involved in the production chain for different products are different. The data product generation involves several complex sequence of operations and data product flow is based on the satellite, sensor, product type, level of correction, format and media. All this is achieved through the efficient computerised IIMS.

Various queries regarding data availability, quality of the data available and area coverage for the user specified requests are handled by NDC, using the utilities provided by IIMS.

4 REFERENCING SCHEME

4.1 Introduction

Referencing scheme which is unique for each satellite mission, is a means of conveniently identifying the geographic location of points on the earth. This helps image referencing with reference to ground location. This scheme is designated by Paths and Rows. The Path-Row concept is based on the nominal orbital characteristics. This section describes the referencing scheme and related information.

4.2 Path

An orbit is the course of motion taken by the satellite, in space and the descending (South bound) ground trace of the orbit is called a 'Path'. The satellite completes 1867 orbits in 126 days with an orbital period of 97.18 minutes. This way, the satellite completes approximately 15 orbits per day. Though the number of orbits and paths are same, the designated path number in the referencing scheme and the orbit number are not the same. On day one (D1), the satellite covers orbit numbers 1 to 15, which as per the referencing scheme will be path numbers 1, 1742, 1616, 1490, 1364, 1238, 1112, 986, 860, 734, 608, 482, 356, 230 and 104 assuming that the repeat cycle starts with path 1. So orbit number 1 corresponds to path 1, orbit number 2 to path 1742, orbit number 3 to path 1616 etc., The sixteenth orbit or first orbit of day two (D2), is path 1845 which will be to the west of path 1 and is separated from path 1 by 23 paths. Path number one is assigned to the track which is at 30.0 deg West longitude on the equator. The gap between successive paths is 0.1928 deg (21.46 km) at equator. Since the gap between adjacent paths is very less, it is not possible to avoid high elevation passes above 86 deg elevation over a given ground station. During operation, the actual path may vary from the nominal path pattern due to variations in the orbit by perturbations. Therefore, the orbit is adjusted periodically, after certain amount of drift, to bring the satellite into the specified orbit. The path pattern is controlled within ± 1 km about the nominal path pattern.

4.3 Row

Along a path, the continuous stream of data is segmented into a number of scenes of convenient size. While framing the scenes, equator is taken as the reference. With equator as one of the scene centres, a scene is formed considering 5250 lines on either side of the centre i.e. total number of lines per scene is 10500. Scene centres are fixed on either side of the equator at a gap of every 10000 lines up to +82 deg and -82 deg latitude. The uniformly separated scene centres are, such that, same rows of different paths fall at the same latitude. The lines joining the corresponding scene centres of different paths are parallel to the equator and are called Rows. The row number 1 falls around 82 deg North latitude. Row number of the scene lying on the equator is 393 and row 785 is at -82 deg latitude. The range of paths from 380 to 700 and rows from 185 to 445 cover the Indian region.

4.4 Scene definition

The camera scans the ground track line by line continuously. The satellite motion along the track provides continuous imaging of the ground. This continuous stream of data is segmented to convenient sizes. These segments are called scenes. The camera system takes certain amount of time to read and register the CCD array data. This integration time is chosen prior to launch and is fixed throughout the mission. The integration time for each camera is so chosen, that, it is equivalent to the time taken by the satellite in nominal orbit to traverse the scan line distance of the respective cameras. The across track width is limited by the swath of the respective cameras. Due to the line-by-line mode of scanning, the along track scan is a continuous strip and is divided into a number of uniform scenes. Each line of the camera consists of a fixed number of CCD elements in the form of an array. The image obtained by one CCD element is a pixel. The pixel size on ground is equal to the resolution of the respective cameras. The across track length of the scan (swath) is determined by the pixel size, number of elements in a line and canting. Each imaging

sensor scans line by line during its integration time, which is fixed for each camera. Thus, each camera scans a fixed number of lines in fixed intervals of time. Therefore, the along track length of a scene is based on the number of lines used to constitute that scene.

4.5 Use of referencing scheme

The Path-Row referencing scheme eliminates the usage of latitude and longitudes and facilitates convenient and unique identification of a geographic location. It is useful in preparing accession and product catalogues and reduces the complexity of data products generation. Using the referencing scheme, the user can arrive at the number of scenes that covers his area of interest.

However, due to orbit and attitude variations during operation, the actual scene may be displaced slightly from the nominal scene defined in the referencing scheme. Hence, if the user area of interest lies in border region of any scene, the user may have to order the overlapping scenes in addition to the nominal scene.

4.6 Referencing scheme and scene coverage

The Aft camera with less tilt and swath is considered as the reference for stereo scene. The swath of Aft camera scene is 26.8 km. Since the swath of Aft

camera is greater than the path to path distance (21.46 km), the sensor scans the entire globe once in every cycle without gaps. The referencing scheme of Cartosat-1 consists of 1867 paths numbered from west to east. Each path consists of 785 rows. Consecutive paths are covered with a separation of eleven days. If Path n is covered on day one, Path n-1 will be covered after eleven days gap (Figure 4.1).

Each Aft camera scene covers an area of 26.8 km x 26.8 km. The side lap between the two scenes is 5.3 km at the equator. The overlap between successive scenes in a path is 1.3 km. (Figure 4.2)

4.7 Determination of observation dates

For the chosen path, the ground track repeats every 126 days after 1867 orbits. Therefore, the coverage pattern is almost constant. The deviations of orbit and attitude parameters are controlled within limits such that the coverage pattern remains almost constant through out the mission. Therefore, on any given day, it is possible to determine the orbit which will trace a designated path. Once the path is known, with the help of referencing scheme, it is possible to find out the region covered by that path. Therefore, an orbital calendar, giving the details of paths, covered on different days will be helpful to users to plan their procurement of satellite data products.

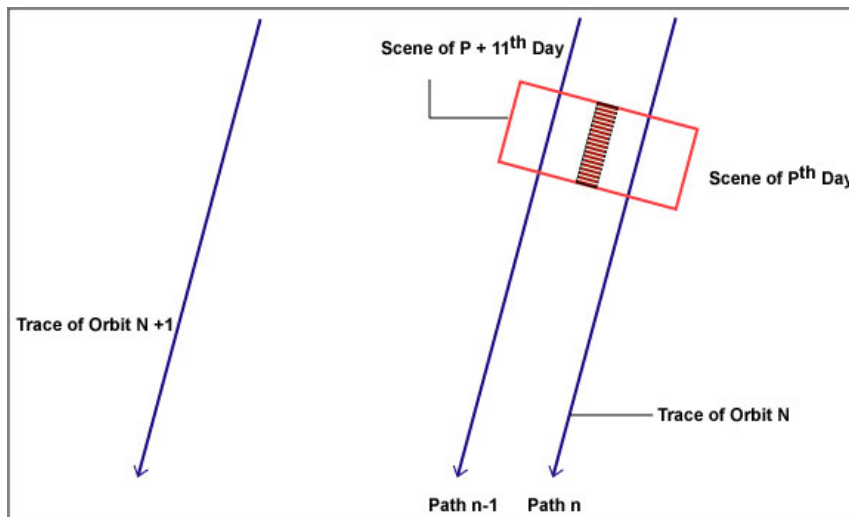

Figure.4.1 Stereo scene coverage

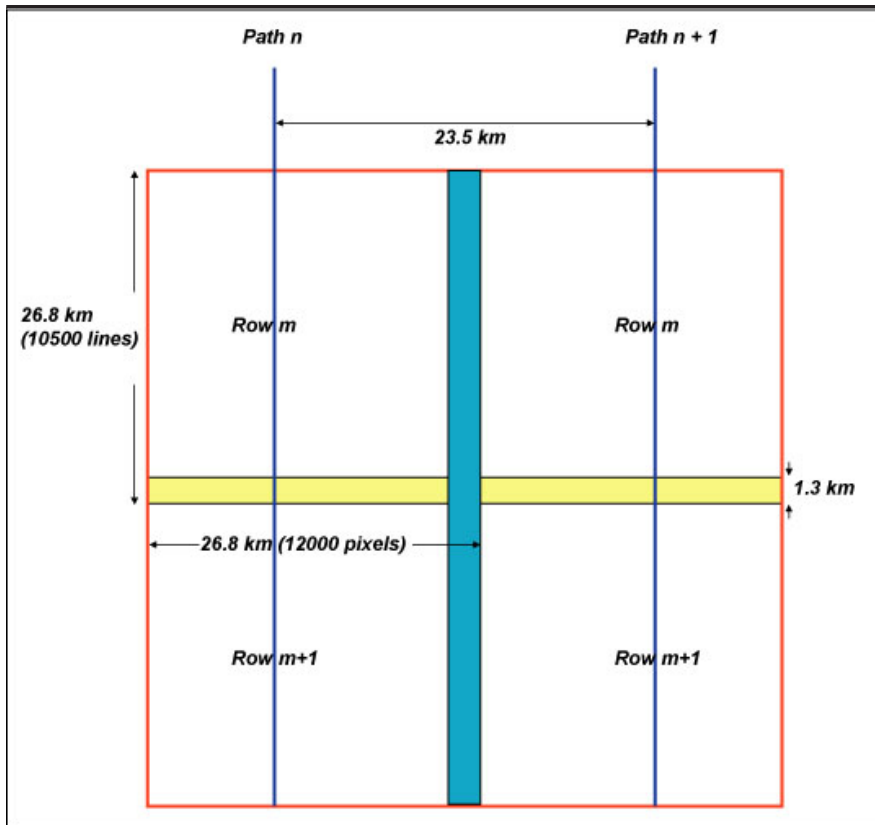

Figure.4.2 stereo scene layout

Table 4.1 shows a typical path calendar for one repeat cycle. One can know the date of occurrence of the path pertaining to the region of interest with the help of path calendar. Thus, it is possible to know on which day the required data has been collected or is going to be collected.

4.8 Estimation of Path and Row, local clock time and other details for any point on Indian sub-continent

The procedure outlined below may be used to determine the path and row, Greenwich Meridian Time (GMT) and the local clock time when the satellite passes over any point in the Indian sub-continent.

- i. Define the latitude and longitude of the point of interest over Indian region.
- ii. Determine the approximate descending node as follows:
Locate the latitude of the point of interest in Table

4.2. Table 4.2 gives the longitudinal difference from the given longitude to the descending node longitude as a function of latitude.

Read the value of longitude from this table. If the latitude falls within two values, then, interpolate and get required longitude.

Add this value to the longitude of the point of interest, to get rough estimate of descending node longitude.

iii. The actual descending node details are obtained as follows:

Table 4.3 gives the descending node longitude of all paths over Indian region. Find the path, nearest to the longitude computed in step ii. This gives the path number and descending node longitude of the path.

Table 4.4 gives the descending node time (GMT) expected for each path over Indian sub-continent.

iv. GMT at the point of interest is found as follows:

Given a latitude, using the nominal inclination of the orbit, the time of descending node can be calculated. Add the time to the GMT of the descending node as obtained in step 3, by carefully noting the algebraic sign.

v. The Indian Standard Time (IST) is obtained by adding five and a half hours to the time (GMT) obtained in step iv.

vi. Table 4.2 gives the row numbers versus latitude. Find the nearest row latitude from this table and assign the same row number. Thus, with the above procedure, the path and row numbers and other details of the point of interest can be obtained.

4.9 Framing procedure and scene centre and corner co-ordinates evaluation for the referencing scheme

Based on the reference orbit, ephemeris is generated for all the 1867 orbits of on coverage cycle. From the ephemeris, all the details about the paths over the Indian sub-continent are extracted. These details are path number, descending node details etc. Descending nodal points of all the paths are scene centres. All the details of stereo scenes along the paths are obtained taking descending nodal points as reference. While assigning the row numbers, counting is done from northern most scene centre on a path. The size of a stereo scene is 12000 pixels X 10500 lines. Once scene centre time is known, by taking 5250 lines above and below that point the scene start and end timings for the Fore and Aft scenes can be obtained.

In this process, the along track overlap is automatically taken care and side lap is given by ground track placements. Similarly, all the stereo scenes are sized along the track. By evaluating corner coordinates of each scene, the framing is completed.

4. 10 Deviations of orbit and attitude parameters and its effect on the image

The referencing scheme has been generated for the reference orbit under ideal conditions. In practice, orbital parameters vary from the reference orbit due to perturbations. Similarly, due to internal and external torques acting on the satellite, its attitude slowly drifts. Both orbit and attitude parameters are controlled within certain limits by the attitude and orbit control system. These perturbations cause the scenes to slightly deviate from the nominally predicted locations. It is therefore necessary for users to understand the deviations to see how best they can use the successive images of a specific scene, for registering, overlaying and for comparison. In this section, a brief summary of the image deviations is given.

Orbit Perturbations :

In order to maintain the required coverage pattern and local time, it is essential that the defined sun-synchronous orbit be maintained throughout the

operational life time of the satellite. Even after the launch vehicle injection errors are removed, the perturbations to the orbit, orbit determination and orbit adjust system uncertainties cause deviations from the ideal sun-synchronous orbit. Hence, orbital parameters have to be controlled near to the ideal orbit within the tolerance specified. The main perturbations are due to atmospheric drag, asphericity of the Earth and to some extent by lunisolar gravitational attraction. Deviations caused by these are corrected by periodic orbit adjust operations. The effect of the deviations within the limits of these corrections is discussed in subsequent sections.

Atmospheric Drag :

Atmospheric Drag causes gradual loss of altitude continuously, if the altitude is not controlled by manoeuvres. Due to altitude decay, the time period of the orbit changes which affects the ground track pattern and therefore coverage pattern. It is planned to control the ground track pattern to within ± 1 km of the nominal pattern. This would be achieved by suitably controlling the altitude within corresponding limits. Periodicity of altitude corrections depends on the decay rate.

Asphericity of the Earth :

Asphericity of the earth has two major effects, namely

- i. Circular orbit becomes eccentric and eccentricity varies in a sinusoidal fashion.
- ii. Apsidal line, that is the line joining the perigee and apogee points in the orbit, rotates in the orbital plane. The period of this rotation for IRS orbit is estimated to be around 132 days. Due to the frozen orbit concept, to be adopted for Cartosat-1, the perigee is almost maintained near the orbital pole and the mean eccentricity is maintained at 0.001.

Eccentricity leads to variations in altitude as well as velocity. Since the earth is geoid shaped, even for a pure circular orbit, satellite does not have same altitude through out the orbit. The altitude variations cause scale variations of the image (Figure. 4.7) for

a given camera system. Due to the frozen perigee, altitude variations over the Indian region would be within 10 km.

Equator is taken as the reference for framing the scenes while generating the referencing scheme. Equator is also being taken as reference during the actual operations and the descending node point is determined based on the current ephemeris. Hence, the along track error due to eccentricity is negligible at this point. Taking this point as reference, the other stereo scene centres are marked on a given path at equal time intervals.

Luni-Solar Gravitational Attraction and Solar Radiation Pressure :

Additional perturbations to the orbit are examined here. This includes luni-solar gravitational attraction and solar radiation pressure. For IRS, the solar radiation pressure has negligible effects, whereas, luni-solar gravitational attraction causes secular variations of about 0.041 degree per year in inclination apart from periodic variations. Variations in the inclination affects ground track pattern as well as local time. Since the variations are secular, compensation can be done easily. The inclination is biased by 0.02 degree towards a favourable side, so that ,it drifts to the nominal value after 6 months. Yearly corrections to inclination will be done to restrict its contribution to local time variation within ± 0.4 minutes as shown in Figure.4.2.8.

4.11 Orbit determination and prediction errors

It is rather difficult to model accurately all the perturbing forces to represent the true motion of the satellite. When orbit predictions are carried out, the trajectory deviates from the true trajectory and the deviation builds up continuously. Therefore, periodic orbit determinations would be carried out using tracking observations of the satellite and also using GPS data obtained from the onboard SPS. The positional accuracy of the definitive orbit would be less than 20 meters (3 sigma) using SPS data and less than 80 meters (3 sigma) in case of orbit determination using tracking observations.

4.12 Deviations of attitude parameters

To align the payload cameras along the nadir line, continuously, IRS has been configured for 3 axis stabilized mode of attitude which is achieved through a set of attitude sensors and control hardware. Controlling is necessary due to environmental and internal torques which affect the attitude stabilization continuously. Due to the presence of various errors in attitude sensing and controlling, the attitude would be controlled up to 0.05 degree in each of the yaw, roll and pitch axis with star sensor in control loop. The effect of pitch, roll and yaw on image is shown in Figure 4.9. The pitch error shifts the scene in the along track direction, whereas, roll error shifts the scene in the across-track direction. Due to yaw error, the scene is rotated through .the same angle about the nominal scene centre. The attitude determination accuracy is better than the controlling accuracy and would be better than ± 0.014 degree in each of the axes using star sensor. The deviations of scenes from the nominal depend only on the controlling accuracy. Determined attitude information is used to correct the image and for annotation.

Across Track deviations Of the Image :

Across track deviations of the image essentially depends on ground track pattern deviations, the accuracy of information on ground track, roll and yaw errors etc., Taking into account the uncertainties in orbit determination and orbit adjust system, the ground track pattern would be controlled within ± 1 km. about the nominal pattern. It is clear that the above implies a reduction in effective window to account for orbit determination and orbit adjust system uncertainties. Roll error of 0.05 degree causes track deviations of about 0.5 km and yaw error of 0.05 degree would cause 0.09 km under the worst case. The Root Sum Square (RSS) of all these deviations is about 1.1 km.

Along Track deviations Of the Image :

The along track deviations of the image are due to eccentricity, orbit determination /prediction accuracy, the shape of the earth, and attitude control accuracy. The eccentricity effect is considered to some extent

by choosing the frozen orbit concept. Velocity variations due to eccentricity are considered in the referencing scheme itself. Pitch error of 0.05 degree would cause 500 m along track deviation at the worst case. The component of yaw error introduces 80 m. Considering the position accuracy of 20m along track deviation is about 507 m (RSS).

4.13 Image framing during actual operations

In the earlier section, the deviations of the actual scenes with respect to nominal scenes have been described. For mosaic generation, user may have to use scenes obtained in different coverage cycles. With such large deviations, it was found that mosaic formation may be difficult, and also the user may have to order several scenes, to get the required area information. During the process of evolution, it was found that it is difficult to reduce the across track deviations, whereas, with an appropriate procedure for image framing, there is a possibility of reducing the along track deviations. Therefore, it was decided to adopt this method during actual operations. It may be noted, that, image deviation means the distance between the centre of the actual scene obtained and the centre of the corresponding scene defined in the path-row referencing scheme. This should be distinguished from the location accuracy determined by the orbit and attitude information.

The following framing procedure is being adopted:

- i. All the relevant row latitudes as defined in the referencing scheme should be stored.
- ii. The same row latitudes for actual scenes also should be adopted. This is accomplished by interpolating the time for a given row latitude along the path.
- iii. All the stereo scene centres along the path should be marked by following the above procedure.
- iv. The stereo scenes about the above scene centres should be constructed by taking 5250 lines above and below about these points along the path. The end and beginning of each stereo scene along the path should be marked.

The main advantage of the above procedure is, that, major portion of along track deviation with respect to the nominal scenes get reduced. Thus, the final deviations are

along track : ± 507 m

across track : ± 1.1 km

4.14 Impact of the deviations on overlap and side lap during operational life time

While framing the images for the referencing scheme, adequate overlap (along track) and sidelap (across track), are provided to aid the users to form a mosaic for a particular area or complete Indian region. If the quality of all the images is good, then, it is possible to create a mosaic within the same coverage cycle. However, in actual practice, quality of all the images may not be good due to the presence of cloud or some other reasons. Therefore, it is necessary to take images of different coverage cycles to generate the mosaic. In ideal situations, overlap or sidelap between adjacent images will exist. However, in actual practice, the deviation mentioned in the earlier sections will affect sidelap/overlap between images of one cycle and corresponding images of any other cycle during the operational life time of the satellite. For example, a scene of cycle N1 corresponding to path and row of P1 and R1 has a prescribed amount of overlap with a scene of the same cycle corresponding to path and row of P1, R1 + 1. However, it may not have the same amount of overlap, due to deviations; with a scene of cycle N2 corresponding to path and row of P1, R1 + 1. Similar is the situation for sidelap. Overlap or side lap variation due to the deviations mentioned in the earlier section and due to scale variation of the image because of variation in the altitude. However, scale variation affects only sidelap but not overlap as scanning is accomplished line by line, along the track.

Overlap Variation :

The nominal overlap provided between any two stereo scenes is 1.3 km. The maximum deviation (along the track) is of the order of 507 m, with the

new framing procedure. Due to this, the distance between two scenes of different cycles will be slightly different.

Sidelap Variation :

Sidelap is the common area between two adjacent scenes of any two consecutive paths. However, sidelap between scenes of two consecutive paths of different cycles is affected by across track deviations and scale variations. The nominal sidelap increases from equator to northern latitudes. Due to this, deviation in sidelap happens at the equator. Therefore, the sidelap variation at equator is discussed here. The nominal sidelap at the equator would be 5.3 km. for stereo scene. The across track deviation would be the order of ± 1.1 km near the equator. Therefore, the two adjacent scenes of different cycles can be near by or away by twice this amount.

4.15 Accuracy of orbit and attitude parameters used for generating data products

In the earlier sections, the deviations overlap and sidelap variations of the actual scenes from the nominal scenes were described. Since orbit and attitude deviations are carried out continuously, during the mission, the information about the actual scene (deviated from the reference scheme) are known to the best accuracy possible under operational environment. This information is used to generate browse, standard and other products.

Table 4.1 Cartosat-1 Path Calendar for the year 2007

01-Jan-2007	874	748	622	496	370	244	118	1859	1733	1607	1481	1355	1229	1103	977
02-Jan-2007	851	725	599	473	347	221	95	1836	1710	1584	1458	1332	1206	1080	954
03-Jan-2007	828	702	576	450	324	198	72	1813	1687	1561	1435	1309	1183	1057	
04-Jan-2007	931	805	679	553	427	301	175	49	1790	1664	1538	1412	1286	1160	1034
05-Jan-2007	908	782	656	530	404	278	152	26	1767	1641	1515	1389	1263	1137	1011
06-Jan-2007	885	759	633	507	381	255	129	3	1744	1618	1492	1366	1240	1114	988
07-Jan-2007	862	736	610	484	358	232	106	1847	1721	1595	1469	1343	1217	1091	965
08-Jan-2007	839	713	587	461	335	209	83	1824	1698	1572	1446	1320	1194	1068	942
09-Jan-2007	816	690	564	438	312	186	60	1801	1675	1549	1423	1297	1171	1045	
10-Jan-2007	919	793	667	541	415	289	163	37	1778	1652	1526	1400	1274	1148	1022
11-Jan-2007	896	770	644	518	392	266	140	14	1755	1629	1503	1377	1251	1125	999
12-Jan-2007	873	747	621	495	369	243	117	1858	1732	1606	1480	1354	1228	1102	976
13-Jan-2007	850	724	598	472	346	220	94	1835	1709	1583	1457	1331	1205	1079	953
14-Jan-2007	827	701	575	449	323	197	71	1812	1686	1560	1434	1308	1182	1056	
15-Jan-2007	930	804	678	552	426	300	174	48	1789	1663	1537	1411	1285	1159	1033
16-Jan-2007	907	781	655	529	403	277	151	25	1766	1640	1514	1388	1262	1136	1010
17-Jan-2007	884	758	632	506	380	254	128	2	1743	1617	1491	1365	1239	1113	987
18-Jan-2007	861	735	609	483	357	231	105	1846	1720	1594	1468	1342	1216	1090	964
19-Jan-2007	838	712	586	460	334	208	82	1823	1697	1571	1445	1319	1193	1067	941
20-Jan-2007	815	689	563	437	311	185	59	1800	1674	1548	1422	1296	1170	1044	
21-Jan-2007	918	792	666	540	414	288	162	36	1777	1651	1525	1399	1273	1147	1021
22-Jan-2007	895	769	643	517	391	265	139	13	1754	1628	1502	1376	1250	1124	998
23-Jan-2007	872	746	620	494	368	242	116	1857	1731	1605	1479	1353	1227	1101	975
24-Jan-2007	849	723	597	471	345	219	93	1834	1708	1582	1456	1330	1204	1078	952
25-Jan-2007	826	700	574	448	322	196	70	1811	1685	1559	1433	1307	1181	1055	
26-Jan-2007	929	803	677	551	425	299	173	47	1788	1662	1536	1410	1284	1158	1032
27-Jan-2007	906	780	654	528	402	276	150	24	1765	1639	1513	1387	1261	1135	1009
28-Jan-2007	883	757	631	505	379	253	127	1	1742	1616	1490	1364	1238	1112	986
29-Jan-2007	860	734	608	482	356	230	104	1845	1719	1593	1467	1341	1215	1089	963
30-Jan-2007	837	711	585	459	333	207	81	1822	1696	1570	1444	1318	1192	1066	
31-Jan-2007	940	814	688	562	436	310	184	58	1799	1673	1547	1421	1295	1169	1043
01-Feb-2007	917	791	665	539	413	287	161	35	1776	1650	1524	1398	1272	1146	1020
02-Feb-2007	894	768	642	516	390	264	138	12	1753	1627	1501	1375	1249	1123	997
03-Feb-2007	871	745	619	493	367	241	115	1856	1730	1604	1478	1352	1226	1100	974
04-Feb-2007	848	722	596	470	344	218	92	1833	1707	1581	1455	1329	1203	1077	951
05-Feb-2007	825	699	573	447	321	195	69	1810	1684	1558	1432	1306	1180	1054	
06-Feb-2007	928	802	676	550	424	298	172	46	1787	1661	1535	1409	1283	1157	1031
07-Feb-2007	905	779	653	527	401	275	149	23	1764	1638	1512	1386	1260	1134	1008
08-Feb-2007	882	756	630	504	378	252	126	1867	1741	1615	1489	1363	1237	1111	985
09-Feb-2007	859	733	607	481	355	229	103	1844	1718	1592	1466	1340	1214	1088	962
10-Feb-2007	836	710	584	458	332	206	80	1821	1695	1569	1443	1317	1191	1065	
11-Feb-2007	939	813	687	561	435	309	183	57	1798	1672	1546	1420	1294	1168	1042
12-Feb-2007	916	790	664	538	412	286	160	34	1775	1649	1523	1397	1271	1145	1019
13-Feb-2007	893	767	641	515	389	263	137	11	1752	1626	1500	1374	1248	1122	996
14-Feb-2007	870	744	618	492	366	240	114	1855	1729	1603	1477	1351	1225	1099	973
15-Feb-2007	847	721	595	469	343	217	91	1832	1706	1580	1454	1328	1202	1076	950
16-Feb-2007	824	698	572	446	320	194	68	1809	1683	1557	1431	1305	1179	1053	
17-Feb-2007	927	801	675	549	423	297	171	45	1786	1660	1534	1408	1282	1156	1030
18-Feb-2007	904	778	652	526	400	274	148	22	1763	1637	1511	1385	1259	1133	1007
19-Feb-2007	881	755	629	503	377	251	125	1866	1740	1614	1488	1362	1236	1110	984
20-Feb-2007	858	732	606	480	354	228	102	1843	1717	1591	1465	1339	1213	1087	961
21-Feb-2007	835	709	583	457	331	205	79	1820	1694	1568	1442	1316	1190	1064	
22-Feb-2007	938	812	686	560	434	308	182	56	1797	1671	1545	1419	1293	1167	1041
23-Feb-2007	915	789	663	537	411	285	159	33	1774	1648	1522	1396	1270	1144	1018
24-Feb-2007	892	766	640	514	388	262	136	10	1751	1625	1499	1373	1247	1121	995
25-Feb-2007	869	743	617	491	365	239	113	1854	1728	1602	1476	1350	1224	1098	972
26-Feb-2007	846	720	594	468	342	216	90	1831	1705	1579	1453	1327	1201	1075	949
27-Feb-2007	823	697	571	445	319	193	67	1808	1682	1556	1430	1304	1178	1052	
28-Feb-2007	926	800	674	548	422	296	170	44	1785	1659	1533	1407	1281	1155	1029

01-Mar-2007	903	777	651	525	399	273	147	21	1762	1636	1510	1384	1258	1132	1006
02-Mar-2007	880	754	628	502	376	250	124	1865	1739	1613	1487	1361	1235	1109	983
03-Mar-2007	857	731	605	479	353	227	101	1842	1716	1590	1464	1338	1212	1086	960
04-Mar-2007	834	708	582	456	330	204	78	1819	1693	1567	1441	1315	1189	1063	
05-Mar-2007	937	811	685	559	433	307	181	55	1796	1670	1544	1418	1292	1166	1040
06-Mar-2007	914	788	662	536	410	284	158	32	1773	1647	1521	1395	1269	1143	1017
07-Mar-2007	891	765	639	513	387	261	135	9	1750	1624	1498	1372	1246	1120	994
08-Mar-2007	868	742	616	490	364	238	112	1853	1727	1601	1475	1349	1223	1097	971
09-Mar-2007	845	719	593	467	341	215	89	1830	1704	1578	1452	1326	1200	1074	948
10-Mar-2007	822	696	570	444	318	192	66	1807	1681	1555	1429	1303	1177	1051	
11-Mar-2007	925	799	673	547	421	295	169	43	1784	1658	1532	1406	1280	1154	1028
12-Mar-2007	902	776	650	524	398	272	146	20	1761	1635	1509	1383	1257	1131	1005
13-Mar-2007	879	753	627	501	375	249	123	1864	1738	1612	1486	1360	1234	1108	982
14-Mar-2007	856	730	604	478	352	226	100	1841	1715	1589	1463	1337	1211	1085	959
15-Mar-2007	833	707	581	455	329	203	77	1818	1692	1566	1440	1314	1188	1062	
16-Mar-2007	936	810	684	558	432	306	180	54	1795	1669	1543	1417	1291	1165	1039
17-Mar-2007	913	787	661	535	409	283	157	31	1772	1646	1520	1394	1268	1142	1016
18-Mar-2007	890	764	638	512	386	260	134	8	1749	1623	1497	1371	1245	1119	993
19-Mar-2007	867	741	615	489	363	237	111	1852	1726	1600	1474	1348	1222	1096	970
20-Mar-2007	844	718	592	466	340	214	88	1829	1703	1577	1451	1325	1199	1073	947
21-Mar-2007	821	695	569	443	317	191	65	1806	1680	1554	1428	1302	1176	1050	
22-Mar-2007	924	798	672	546	420	294	168	42	1783	1657	1531	1405	1279	1153	1027
23-Mar-2007	901	775	649	523	397	271	145	19	1760	1634	1508	1382	1256	1130	1004
24-Mar-2007	878	752	626	500	374	248	122	1863	1737	1611	1485	1359	1233	1107	981
25-Mar-2007	855	729	603	477	351	225	99	1840	1714	1588	1462	1336	1210	1084	958
26-Mar-2007	832	706	580	454	328	202	76	1817	1691	1565	1439	1313	1187	1061	
27-Mar-2007	935	809	683	557	431	305	179	53	1794	1668	1542	1416	1290	1164	1038
28-Mar-2007	912	786	660	534	408	282	156	30	1771	1645	1519	1393	1267	1141	1015
29-Mar-2007	889	763	637	511	385	259	133	7	1748	1622	1496	1370	1244	1118	992
30-Mar-2007	866	740	614	488	362	236	110	1851	1725	1599	1473	1347	1221	1095	969
31-Mar-2007	843	717	591	465	339	213	87	1828	1702	1576	1450	1324	1198	1072	946

01-Apr-2007	820	694	568	442	316	190	64	1805	1679	1553	1427	1301	1175	1049	
02-Apr-2007	923	797	671	545	419	293	167	41	1782	1656	1530	1404	1278	1152	1026
03-Apr-2007	900	774	648	522	396	270	144	18	1759	1633	1507	1381	1255	1129	1003
04-Apr-2007	877	751	625	499	373	247	121	1862	1736	1610	1484	1358	1232	1106	980
05-Apr-2007	854	728	602	476	350	224	98	1839	1713	1587	1461	1335	1209	1083	957
06-Apr-2007	831	705	579	453	327	201	75	1816	1690	1564	1438	1312	1186	1060	
07-Apr-2007	934	808	682	556	430	304	178	52	1793	1667	1541	1415	1289	1163	1037
08-Apr-2007	911	785	659	533	407	281	155	29	1770	1644	1518	1392	1266	1140	1014
09-Apr-2007	888	762	636	510	384	258	132	6	1747	1621	1495	1369	1243	1117	991
10-Apr-2007	865	739	613	487	361	235	109	1850	1724	1598	1472	1346	1220	1094	968
11-Apr-2007	842	716	590	464	338	212	86	1827	1701	1575	1449	1323	1197	1071	945
12-Apr-2007	819	693	567	441	315	189	63	1804	1678	1552	1426	1300	1174	1048	
13-Apr-2007	922	796	670	544	418	292	166	40	1781	1655	1529	1403	1277	1151	1025
14-Apr-2007	899	773	647	521	395	269	143	17	1758	1632	1506	1380	1254	1128	1002
15-Apr-2007	876	750	624	498	372	246	120	1861	1735	1609	1483	1357	1231	1105	979
16-Apr-2007	853	727	601	475	349	223	97	1838	1712	1586	1460	1334	1208	1082	956
17-Apr-2007	830	704	578	452	326	200	74	1815	1689	1563	1437	1311	1185	1059	
18-Apr-2007	933	807	681	555	429	303	177	51	1792	1666	1540	1414	1288	1162	1036
19-Apr-2007	910	784	658	532	406	280	154	28	1769	1643	1517	1391	1265	1139	1013
20-Apr-2007	887	761	635	509	383	257	131	5	1746	1620	1494	1368	1242	1116	990
21-Apr-2007	864	738	612	486	360	234	108	1849	1723	1597	1471	1345	1219	1093	967
22-Apr-2007	841	715	589	463	337	211	85	1826	1700	1574	1448	1322	1196	1070	944
23-Apr-2007	818	692	566	440	314	188	62	1803	1677	1551	1425	1299	1173	1047	
24-Apr-2007	921	795	669	543	417	291	165	39	1780	1654	1528	1402	1276	1150	1024
25-Apr-2007	898	772	646	520	394	268	142	16	1757	1631	1505	1379	1253	1127	1001
26-Apr-2007	875	749	623	497	371	245	119	1860	1734	1608	1482	1356	1230	1104	978
27-Apr-2007	852	726	600	474	348	222	96	1837	1711	1585	1459	1333	1207	1081	955
28-Apr-2007	829	703	577	451	325	199	73	1814	1688	1562	1436	1310	1184	1058	
29-Apr-2007	932	806	680	554	428	302	176	50	1791	1665	1539	1413	1287	1161	1035
30-Apr-2007	909	783	657	531	405	279	153	27	1768	1642	1516	1390	1264	1138	1012

01-May-2007	886	760	634	508	382	256	130	4	1745	1619	1493	1367	1241	1115	989
02-May-2007	863	737	611	485	359	233	107	1848	1722	1596	1470	1344	1218	1092	966
03-May-2007	840	714	588	462	336	210	84	1825	1699	1573	1447	1321	1195	1069	943
04-May-2007	817	691	565	439	313	187	61	1802	1676	1550	1424	1298	1172	1046	
05-May-2007	920	794	668	542	416	290	164	38	1779	1653	1527	1401	1275	1149	1023
06-May-2007	897	771	645	519	393	267	141	15	1756	1630	1504	1378	1252	1126	1000
07-May-2007	874	748	622	496	370	244	118	1859	1733	1607	1481	1355	1229	1103	977
08-May-2007	851	725	599	473	347	221	95	1836	1710	1584	1458	1332	1206	1080	954
09-May-2007	828	702	576	450	324	198	72	1813	1687	1561	1435	1309	1183	1057	
10-May-2007	931	805	679	553	427	301	175	49	1790	1664	1538	1412	1286	1160	1034
11-May-2007	908	782	656	530	404	278	152	26	1767	1641	1515	1389	1263	1137	1011
12-May-2007	885	759	633	507	381	255	129	3	1744	1618	1492	1366	1240	1114	988
13-May-2007	862	736	610	484	358	232	106	1847	1721	1595	1469	1343	1217	1091	965
14-May-2007	839	713	587	461	335	209	83	1824	1698	1572	1446	1320	1194	1068	942
15-May-2007	816	690	564	438	312	186	60	1801	1675	1549	1423	1297	1171	1045	
16-May-2007	919	793	667	541	415	289	163	37	1778	1652	1526	1400	1274	1148	1022
17-May-2007	896	770	644	518	392	266	140	14	1755	1629	1503	1377	1251	1125	999
18-May-2007	873	747	621	495	369	243	117	1858	1732	1606	1480	1354	1228	1102	976
19-May-2007	850	724	598	472	346	220	94	1835	1709	1583	1457	1331	1205	1079	953
20-May-2007	827	701	575	449	323	197	71	1812	1686	1560	1434	1308	1182	1056	
21-May-2007	930	804	678	552	426	300	174	48	1789	1663	1537	1411	1285	1159	1033
22-May-2007	907	781	655	529	403	277	151	25	1766	1640	1514	1388	1262	1136	1010
23-May-2007	884	758	632	506	380	254	128	2	1743	1617	1491	1365	1239	1113	987
24-May-2007	861	735	609	483	357	231	105	1846	1720	1594	1468	1342	1216	1090	964
25-May-2007	838	712	586	460	334	208	82	1823	1697	1571	1445	1319	1193	1067	941
26-May-2007	815	689	563	437	311	185	59	1800	1674	1548	1422	1296	1170	1044	
27-May-2007	918	792	666	540	414	288	162	36	1777	1651	1525	1399	1273	1147	1021
28-May-2007	895	769	643	517	391	265	139	13	1754	1628	1502	1376	1250	1124	998
29-May-2007	872	746	620	494	368	242	116	1857	1731	1605	1479	1353	1227	1101	975
30-May-2007	849	723	597	471	345	219	93	1834	1708	1582	1456	1330	1204	1078	952
31-May-2007	826	700	574	448	322	196	70	1811	1685	1559	1433	1307	1181	1055	

01-Jun-2007	929	803	677	551	425	299	173	47	1788	1662	1536	1410	1284	1158	1032
02-Jun-2007	906	780	654	528	402	276	150	24	1765	1639	1513	1387	1261	1135	1009
03-Jun-2007	883	757	631	505	379	253	127	1	1742	1616	1490	1364	1238	1112	986
04-Jun-2007	860	734	608	482	356	230	104	1845	1719	1593	1467	1341	1215	1089	963
05-Jun-2007	837	711	585	459	333	207	81	1822	1696	1570	1444	1318	1192	1066	
06-Jun-2007	940	814	688	562	436	310	184	58	1799	1673	1547	1421	1295	1169	1043
07-Jun-2007	917	791	665	539	413	287	161	35	1776	1650	1524	1398	1272	1146	1020
08-Jun-2007	894	768	642	516	390	264	138	12	1753	1627	1501	1375	1249	1123	997
09-Jun-2007	871	745	619	493	367	241	115	1856	1730	1604	1478	1352	1226	1100	974
10-Jun-2007	848	722	596	470	344	218	92	1833	1707	1581	1455	1329	1203	1077	951
11-Jun-2007	825	699	573	447	321	195	69	1810	1684	1558	1432	1306	1180	1054	
12-Jun-2007	928	802	676	550	424	298	172	46	1787	1661	1535	1409	1283	1157	1031
13-Jun-2007	905	779	653	527	401	275	149	23	1764	1638	1512	1386	1260	1134	1008
14-Jun-2007	882	756	630	504	378	252	126	1867	1741	1615	1489	1363	1237	1111	985
15-Jun-2007	859	733	607	481	355	229	103	1844	1718	1592	1466	1340	1214	1088	962
16-Jun-2007	836	710	584	458	332	206	80	1821	1695	1569	1443	1317	1191	1065	
17-Jun-2007	939	813	687	561	435	309	183	57	1798	1672	1546	1420	1294	1168	1042
18-Jun-2007	916	790	664	538	412	286	160	34	1775	1649	1523	1397	1271	1145	1019
19-Jun-2007	893	767	641	515	389	263	137	11	1752	1626	1500	1374	1248	1122	996
20-Jun-2007	870	744	618	492	366	240	114	1855	1729	1603	1477	1351	1225	1099	973
21-Jun-2007	847	721	595	469	343	217	91	1832	1706	1580	1454	1328	1202	1076	950
22-Jun-2007	824	698	572	446	320	194	68	1809	1683	1557	1431	1305	1179	1053	
23-Jun-2007	927	801	675	549	423	297	171	45	1786	1660	1534	1408	1282	1156	1030
24-Jun-2007	904	778	652	526	400	274	148	22	1763	1637	1511	1385	1259	1133	1007
25-Jun-2007	881	755	629	503	377	251	125	1866	1740	1614	1488	1362	1236	1110	984
26-Jun-2007	858	732	606	480	354	228	102	1843	1717	1591	1465	1339	1213	1087	961
27-Jun-2007	835	709	583	457	331	205	79	1820	1694	1568	1442	1316	1190	1064	
28-Jun-2007	938	812	686	560	434	308	182	56	1797	1671	1545	1419	1293	1167	1041
29-Jun-2007	915	789	663	537	411	285	159	33	1774	1648	1522	1396	1270	1144	1018
30-Jun-2007	892	766	640	514	388	262	136	10	1751	1625	1499	1373	1247	1121	995

01-Jul-2007	869	743	617	491	365	239	113	1854	1728	1602	1476	1350	1224	1098	972
02-Jul-2007	846	720	594	468	342	216	90	1831	1705	1579	1453	1327	1201	1075	949
03-Jul-2007	823	697	571	445	319	193	67	1808	1682	1556	1430	1304	1178	1052	
04-Jul-2007	926	800	674	548	422	296	170	44	1785	1659	1533	1407	1281	1155	1029
05-Jul-2007	903	777	651	525	399	273	147	21	1762	1636	1510	1384	1258	1132	1006
06-Jul-2007	880	754	628	502	376	250	124	1865	1739	1613	1487	1361	1235	1109	983
07-Jul-2007	857	731	605	479	353	227	101	1842	1716	1590	1464	1338	1212	1086	960
08-Jul-2007	834	708	582	456	330	204	78	1819	1693	1567	1441	1315	1189	1063	
09-Jul-2007	937	811	685	559	433	307	181	55	1796	1670	1544	1418	1292	1166	1040
10-Jul-2007	914	788	662	536	410	284	158	32	1773	1647	1521	1395	1269	1143	1017
11-Jul-2007	891	765	639	513	387	261	135	9	1750	1624	1498	1372	1246	1120	994
12-Jul-2007	868	742	616	490	364	238	112	1853	1727	1601	1475	1349	1223	1097	971
13-Jul-2007	845	719	593	467	341	215	89	1830	1704	1578	1452	1326	1200	1074	948
14-Jul-2007	822	696	570	444	318	192	66	1807	1681	1555	1429	1303	1177	1051	
15-Jul-2007	925	799	673	547	421	295	169	43	1784	1658	1532	1406	1280	1154	1028
16-Jul-2007	902	776	650	524	398	272	146	20	1761	1635	1509	1383	1257	1131	1005
17-Jul-2007	879	753	627	501	375	249	123	1864	1738	1612	1486	1360	1234	1108	982
18-Jul-2007	856	730	604	478	352	226	100	1841	1715	1589	1463	1337	1211	1085	959
19-Jul-2007	833	707	581	455	329	203	77	1818	1692	1566	1440	1314	1188	1062	
20-Jul-2007	936	810	684	558	432	306	180	54	1795	1669	1543	1417	1291	1165	1039
21-Jul-2007	913	787	661	535	409	283	157	31	1772	1646	1520	1394	1268	1142	1016
22-Jul-2007	890	764	638	512	386	260	134	8	1749	1623	1497	1371	1245	1119	993
23-Jul-2007	867	741	615	489	363	237	111	1852	1726	1600	1474	1348	1222	1096	970
24-Jul-2007	844	718	592	466	340	214	88	1829	1703	1577	1451	1325	1199	1073	947
25-Jul-2007	821	695	569	443	317	191	65	1806	1680	1554	1428	1302	1176	1050	
26-Jul-2007	924	798	672	546	420	294	168	42	1783	1657	1531	1405	1279	1153	1027
27-Jul-2007	901	775	649	523	397	271	145	19	1760	1634	1508	1382	1256	1130	1004
28-Jul-2007	878	752	626	500	374	248	122	1863	1737	1611	1485	1359	1233	1107	981
29-Jul-2007	855	729	603	477	351	225	99	1840	1714	1588	1462	1336	1210	1084	958
30-Jul-2007	832	706	580	454	328	202	76	1817	1691	1565	1439	1313	1187	1061	
31-Jul-2007	935	809	683	557	431	305	179	53	1794	1668	1542	1416	1290	1164	1038

01-Aug-2007	912	786	660	534	408	282	156	30	1771	1645	1519	1393	1267	1141	1015
02-Aug-2007	889	763	637	511	385	259	133	7	1748	1622	1496	1370	1244	1118	992
03-Aug-2007	866	740	614	488	362	236	110	1851	1725	1599	1473	1347	1221	1095	969
04-Aug-2007	843	717	591	465	339	213	87	1828	1702	1576	1450	1324	1198	1072	946
05-Aug-2007	820	694	568	442	316	190	64	1805	1679	1553	1427	1301	1175	1049	
06-Aug-2007	923	797	671	545	419	293	167	41	1782	1656	1530	1404	1278	1152	1026
07-Aug-2007	900	774	648	522	396	270	144	18	1759	1633	1507	1381	1255	1129	1003
08-Aug-2007	877	751	625	499	373	247	121	1862	1736	1610	1484	1358	1232	1106	980
09-Aug-2007	854	728	602	476	350	224	98	1839	1713	1587	1461	1335	1209	1083	957
10-Aug-2007	831	705	579	453	327	201	75	1816	1690	1564	1438	1312	1186	1060	
11-Aug-2007	934	808	682	556	430	304	178	52	1793	1667	1541	1415	1289	1163	1037
12-Aug-2007	911	785	659	533	407	281	155	29	1770	1644	1518	1392	1266	1140	1014
13-Aug-2007	888	762	636	510	384	258	132	6	1747	1621	1495	1369	1243	1117	991
14-Aug-2007	865	739	613	487	361	235	109	1850	1724	1598	1472	1346	1220	1094	968
15-Aug-2007	842	716	590	464	338	212	86	1827	1701	1575	1449	1323	1197	1071	945
16-Aug-2007	819	693	567	441	315	189	63	1804	1678	1552	1426	1300	1174	1048	
17-Aug-2007	922	796	670	544	418	292	166	40	1781	1655	1529	1403	1277	1151	1025
18-Aug-2007	899	773	647	521	395	269	143	17	1758	1632	1506	1380	1254	1128	1002
19-Aug-2007	876	750	624	498	372	246	120	1861	1735	1609	1483	1357	1231	1105	979
20-Aug-2007	853	727	601	475	349	223	97	1838	1712	1586	1460	1334	1208	1082	956
21-Aug-2007	830	704	578	452	326	200	74	1815	1689	1563	1437	1311	1185	1059	
22-Aug-2007	933	807	681	555	429	303	177	51	1792	1666	1540	1414	1288	1162	1036
23-Aug-2007	910	784	658	532	406	280	154	28	1769	1643	1517	1391	1265	1139	1013
24-Aug-2007	887	761	635	509	383	257	131	5	1746	1620	1494	1368	1242	1116	990
25-Aug-2007	864	738	612	486	360	234	108	1849	1723	1597	1471	1345	1219	1093	967
26-Aug-2007	841	715	589	463	337	211	85	1826	1700	1574	1448	1322	1196	1070	944
27-Aug-2007	818	692	566	440	314	188	62	1803	1677	1551	1425	1299	1173	1047	
28-Aug-2007	921	795	669	543	417	291	165	39	1780	1654	1528	1402	1276	1150	1024
29-Aug-2007	898	772	646	520	394	268	142	16	1757	1631	1505	1379	1253	1127	1001
30-Aug-2007	875	749	623	497	371	245	119	1860	1734	1608	1482	1356	1230	1104	978
31-Aug-2007	852	726	600	474	348	222	96	1837	1711	1585	1459	1333	1207	1081	955

01-Sep-2007	829	703	577	451	325	199	73	1814	1688	1562	1436	1310	1184	1058	
02-Sep-2007	932	806	680	554	428	302	176	50	1791	1665	1539	1413	1287	1161	1035
03-Sep-2007	909	783	657	531	405	279	153	27	1768	1642	1516	1390	1264	1138	1012
04-Sep-2007	886	760	634	508	382	256	130	4	1745	1619	1493	1367	1241	1115	989
05-Sep-2007	863	737	611	485	359	233	107	1848	1722	1596	1470	1344	1218	1092	966
06-Sep-2007	840	714	588	462	336	210	84	1825	1699	1573	1447	1321	1195	1069	943
07-Sep-2007	817	691	565	439	313	187	61	1802	1676	1550	1424	1298	1172	1046	
08-Sep-2007	920	794	668	542	416	290	164	38	1779	1653	1527	1401	1275	1149	1023
09-Sep-2007	897	771	645	519	393	267	141	15	1756	1630	1504	1378	1252	1126	1000
10-Sep-2007	874	748	622	496	370	244	118	1859	1733	1607	1481	1355	1229	1103	977
11-Sep-2007	851	725	599	473	347	221	95	1836	1710	1584	1458	1332	1206	1080	954
12-Sep-2007	828	702	576	450	324	198	72	1813	1687	1561	1435	1309	1183	1057	
13-Sep-2007	931	805	679	553	427	301	175	49	1790	1664	1538	1412	1286	1160	1034
14-Sep-2007	908	782	656	530	404	278	152	26	1767	1641	1515	1389	1263	1137	1011
15-Sep-2007	885	759	633	507	381	255	129	3	1744	1618	1492	1366	1240	1114	988
16-Sep-2007	862	736	610	484	358	232	106	1847	1721	1595	1469	1343	1217	1091	965
17-Sep-2007	839	713	587	461	335	209	83	1824	1698	1572	1446	1320	1194	1068	942
18-Sep-2007	816	690	564	438	312	186	60	1801	1675	1549	1423	1297	1171	1045	
19-Sep-2007	919	793	667	541	415	289	163	37	1778	1652	1526	1400	1274	1148	1022
20-Sep-2007	896	770	644	518	392	266	140	14	1755	1629	1503	1377	1251	1125	999
21-Sep-2007	873	747	621	495	369	243	117	1858	1732	1606	1480	1354	1228	1102	976
22-Sep-2007	850	724	598	472	346	220	94	1835	1709	1583	1457	1331	1205	1079	953
23-Sep-2007	827	701	575	449	323	197	71	1812	1686	1560	1434	1308	1182	1056	
24-Sep-2007	930	804	678	552	426	300	174	48	1789	1663	1537	1411	1285	1159	1033
25-Sep-2007	907	781	655	529	403	277	151	25	1766	1640	1514	1388	1262	1136	1010
26-Sep-2007	884	758	632	506	380	254	128	2	1743	1617	1491	1365	1239	1113	987
27-Sep-2007	861	735	609	483	357	231	105	1846	1720	1594	1468	1342	1216	1090	964
28-Sep-2007	838	712	586	460	334	208	82	1823	1697	1571	1445	1319	1193	1067	941
29-Sep-2007	815	689	563	437	311	185	59	1800	1674	1548	1422	1296	1170	1044	
30-Sep-2007	918	792	666	540	414	288	162	36	1777	1651	1525	1399	1273	1147	1021

01-Oct-2007	895	769	643	517	391	265	139	13	1754	1628	1502	1376	1250	1124	998
02-Oct-2007	872	746	620	494	368	242	116	1857	1731	1605	1479	1353	1227	1101	975
03-Oct-2007	849	723	597	471	345	219	93	1834	1708	1582	1456	1330	1204	1078	952
04-Oct-2007	826	700	574	448	322	196	70	1811	1685	1559	1433	1307	1181	1055	
05-Oct-2007	929	803	677	551	425	299	173	47	1788	1662	1536	1410	1284	1158	1032
06-Oct-2007	906	780	654	528	402	276	150	24	1765	1639	1513	1387	1261	1135	1009
07-Oct-2007	883	757	631	505	379	253	127	1	1742	1616	1490	1364	1238	1112	986
08-Oct-2007	860	734	608	482	356	230	104	1845	1719	1593	1467	1341	1215	1089	963
09-Oct-2007	837	711	585	459	333	207	81	1822	1696	1570	1444	1318	1192	1066	
10-Oct-2007	940	814	688	562	436	310	184	58	1799	1673	1547	1421	1295	1169	1043
11-Oct-2007	917	791	665	539	413	287	161	35	1776	1650	1524	1398	1272	1146	1020
12-Oct-2007	894	768	642	516	390	264	138	12	1753	1627	1501	1375	1249	1123	997
13-Oct-2007	871	745	619	493	367	241	115	1856	1730	1604	1478	1352	1226	1100	974
14-Oct-2007	848	722	596	470	344	218	92	1833	1707	1581	1455	1329	1203	1077	951
15-Oct-2007	825	699	573	447	321	195	69	1810	1684	1558	1432	1306	1180	1054	
16-Oct-2007	928	802	676	550	424	298	172	46	1787	1661	1535	1409	1283	1157	1031
17-Oct-2007	905	779	653	527	401	275	149	23	1764	1638	1512	1386	1260	1134	1008
18-Oct-2007	882	756	630	504	378	252	126	1867	1741	1615	1489	1363	1237	1111	985
19-Oct-2007	859	733	607	481	355	229	103	1844	1718	1592	1466	1340	1214	1088	962
20-Oct-2007	836	710	584	458	332	206	80	1821	1695	1569	1443	1317	1191	1065	
21-Oct-2007	939	813	687	561	435	309	183	57	1798	1672	1546	1420	1294	1168	1042
22-Oct-2007	916	790	664	538	412	286	160	34	1775	1649	1523	1397	1271	1145	1019
23-Oct-2007	893	767	641	515	389	263	137	11	1752	1626	1500	1374	1248	1122	996
24-Oct-2007	870	744	618	492	366	240	114	1855	1729	1603	1477	1351	1225	1099	973
25-Oct-2007	847	721	595	469	343	217	91	1832	1706	1580	1454	1328	1202	1076	950
26-Oct-2007	824	698	572	446	320	194	68	1809	1683	1557	1431	1305	1179	1053	
27-Oct-2007	927	801	675	549	423	297	171	45	1786	1660	1534	1408	1282	1156	1030
28-Oct-2007	904	778	652	526	400	274	148	22	1763	1637	1511	1385	1259	1133	1007
29-Oct-2007	881	755	629	503	377	251	125	1866	1740	1614	1488	1362	1236	1110	984
30-Oct-2007	858	732	606	480	354	228	102	1843	1717	1591	1465	1339	1213	1087	961
31-Oct-2007	835	709	583	457	331	205	79	1820	1694	1568	1442	1316	1190	1064	

01-Nov-2007	938	812	686	560	434	308	182	56	1797	1671	1545	1419	1293	1167	1041
02-Nov-2007	915	789	663	537	411	285	159	33	1774	1648	1522	1396	1270	1144	1018
03-Nov-2007	892	766	640	514	388	262	136	10	1751	1625	1499	1373	1247	1121	995
04-Nov-2007	869	743	617	491	365	239	113	1854	1728	1602	1476	1350	1224	1098	972
05-Nov-2007	846	720	594	468	342	216	90	1831	1705	1579	1453	1327	1201	1075	949
06-Nov-2007	823	697	571	445	319	193	67	1808	1682	1556	1430	1304	1178	1052	
07-Nov-2007	926	800	674	548	422	296	170	44	1785	1659	1533	1407	1281	1155	1029
08-Nov-2007	903	777	651	525	399	273	147	21	1762	1636	1510	1384	1258	1132	1006
09-Nov-2007	880	754	628	502	376	250	124	1865	1739	1613	1487	1361	1235	1109	983
10-Nov-2007	857	731	605	479	353	227	101	1842	1716	1590	1464	1338	1212	1086	960
11-Nov-2007	834	708	582	456	330	204	78	1819	1693	1567	1441	1315	1189	1063	
12-Nov-2007	937	811	685	559	433	307	181	55	1796	1670	1544	1418	1292	1166	1040
13-Nov-2007	914	788	662	536	410	284	158	32	1773	1647	1521	1395	1269	1143	1017
14-Nov-2007	891	765	639	513	387	261	135	9	1750	1624	1498	1372	1246	1120	994
15-Nov-2007	868	742	616	490	364	238	112	1853	1727	1601	1475	1349	1223	1097	971
16-Nov-2007	845	719	593	467	341	215	89	1830	1704	1578	1452	1326	1200	1074	948
17-Nov-2007	822	696	570	444	318	192	66	1807	1681	1555	1429	1303	1177	1051	
18-Nov-2007	925	799	673	547	421	295	169	43	1784	1658	1532	1406	1280	1154	1028
19-Nov-2007	902	776	650	524	398	272	146	20	1761	1635	1509	1383	1257	1131	1005
20-Nov-2007	879	753	627	501	375	249	123	1864	1738	1612	1486	1360	1234	1108	982
21-Nov-2007	856	730	604	478	352	226	100	1841	1715	1589	1463	1337	1211	1085	959
22-Nov-2007	833	707	581	455	329	203	77	1818	1692	1566	1440	1314	1188	1062	
23-Nov-2007	936	810	684	558	432	306	180	54	1795	1669	1543	1417	1291	1165	1039
24-Nov-2007	913	787	661	535	409	283	157	31	1772	1646	1520	1394	1268	1142	1016
25-Nov-2007	890	764	638	512	386	260	134	8	1749	1623	1497	1371	1245	1119	993
26-Nov-2007	867	741	615	489	363	237	111	1852	1726	1600	1474	1348	1222	1096	970
27-Nov-2007	844	718	592	466	340	214	88	1829	1703	1577	1451	1325	1199	1073	947
28-Nov-2007	821	695	569	443	317	191	65	1806	1680	1554	1428	1302	1176	1050	
29-Nov-2007	924	798	672	546	420	294	168	42	1783	1657	1531	1405	1279	1153	1027
30-Nov-2007	901	775	649	523	397	271	145	19	1760	1634	1508	1382	1256	1130	1004

01-Dec-2007	878	752	626	500	374	248	122	1863	1737	1611	1485	1359	1233	1107	981
02-Dec-2007	855	729	603	477	351	225	99	1840	1714	1588	1462	1336	1210	1084	958
03-Dec-2007	832	706	580	454	328	202	76	1817	1691	1565	1439	1313	1187	1061	
04-Dec-2007	935	809	683	557	431	305	179	53	1794	1668	1542	1416	1290	1164	1038
05-Dec-2007	912	786	660	534	408	282	156	30	1771	1645	1519	1393	1267	1141	1015
06-Dec-2007	889	763	637	511	385	259	133	7	1748	1622	1496	1370	1244	1118	992
07-Dec-2007	866	740	614	488	362	236	110	1851	1725	1599	1473	1347	1221	1095	969
08-Dec-2007	843	717	591	465	339	213	87	1828	1702	1576	1450	1324	1198	1072	946
09-Dec-2007	820	694	568	442	316	190	64	1805	1679	1553	1427	1301	1175	1049	
10-Dec-2007	923	797	671	545	419	293	167	41	1782	1656	1530	1404	1278	1152	1026
11-Dec-2007	900	774	648	522	396	270	144	18	1759	1633	1507	1381	1255	1129	1003
12-Dec-2007	877	751	625	499	373	247	121	1862	1736	1610	1484	1358	1232	1106	980
13-Dec-2007	854	728	602	476	350	224	98	1839	1713	1587	1461	1335	1209	1083	957
14-Dec-2007	831	705	579	453	327	201	75	1816	1690	1564	1438	1312	1186	1060	
15-Dec-2007	934	808	682	556	430	304	178	52	1793	1667	1541	1415	1289	1163	1037
16-Dec-2007	911	785	659	533	407	281	155	29	1770	1644	1518	1392	1266	1140	1014
17-Dec-2007	888	762	636	510	384	258	132	6	1747	1621	1495	1369	1243	1117	991
18-Dec-2007	865	739	613	487	361	235	109	1850	1724	1598	1472	1346	1220	1094	968
19-Dec-2007	842	716	590	464	338	212	86	1827	1701	1575	1449	1323	1197	1071	945
20-Dec-2007	819	693	567	441	315	189	63	1804	1678	1552	1426	1300	1174	1048	
21-Dec-2007	922	796	670	544	418	292	166	40	1781	1655	1529	1403	1277	1151	1025
22-Dec-2007	899	773	647	521	395	269	143	17	1758	1632	1506	1380	1254	1128	1002
23-Dec-2007	876	750	624	498	372	246	120	1861	1735	1609	1483	1357	1231	1105	979
24-Dec-2007	853	727	601	475	349	223	97	1838	1712	1586	1460	1334	1208	1082	956
25-Dec-2007	830	704	578	452	326	200	74	1815	1689	1563	1437	1311	1185	1059	
26-Dec-2007	933	807	681	555	429	303	177	51	1792	1666	1540	1414	1288	1162	1036
27-Dec-2007	910	784	658	532	406	280	154	28	1769	1643	1517	1391	1265	1139	1013
28-Dec-2007	887	761	635	509	383	257	131	5	1746	1620	1494	1368	1242	1116	990
29-Dec-2007	864	738	612	486	360	234	108	1849	1723	1597	1471	1345	1219	1093	967
30-Dec-2007	841	715	589	463	337	211	85	1826	1700	1574	1448	1322	1196	1070	944
31-Dec-2007	818	692	566	440	314	188	62	1803	1677	1551	1425	1299	1173	1047	

Table 4.2 The difference in longitude between a given row and equator

Row	Latitude	Longitude	Row	Latitude	Longitude
1	82.07	-86.39	47	75.98	-38.67
2	82.03	-84.78	48	75.79	-38.13
3	81.98	-83.18	49	75.61	-37.62
4	81.93	-81.6	50	75.42	-37.11
5	81.87	-80.04	51	75.23	-36.62
6	81.81	-78.51	52	75.04	-36.14
7	81.74	-77	53	74.84	-35.67
8	81.66	-75.51	54	74.65	-35.21
9	81.58	-74.05	55	74.46	-34.76
10	81.5	-72.62	56	74.26	-34.33
11	81.41	-71.22	57	74.07	-33.9
12	81.31	-69.85	58	73.87	-33.48
13	81.21	-68.51	59	73.68	-33.07
14	81.11	-67.19	60	73.48	-32.68
15	81	-65.91	61	73.28	-32.29
16	80.88	-64.66	62	73.08	-31.9
17	80.77	-63.44	63	72.88	-31.53
18	80.65	-62.25	64	72.68	-31.17
19	80.52	-61.09	65	72.48	-30.81
20	80.39	-59.96	66	72.28	-30.46
21	80.26	-58.86	67	72.08	-30.12
22	80.13	-57.79	68	71.88	-29.78
23	79.99	-56.75	69	71.67	-29.45
24	79.85	-55.73	70	71.47	-29.13
25	79.7	-54.74	71	71.27	-28.81
26	79.55	-53.78	72	71.06	-28.5
27	79.4	-52.85	73	70.86	-28.2
28	79.25	-51.94	74	70.65	-27.9
29	79.1	-51.06	75	70.45	-27.61
30	78.94	-50.2	76	70.24	-27.32
31	78.78	-49.36	77	70.04	-27.04
32	78.62	-48.55	78	69.83	-26.77
33	78.45	-47.76	79	69.62	-26.5
34	78.29	-46.99	80	69.41	-26.23
35	78.12	-46.24	81	69.21	-25.97
36	77.95	-45.51	82	69	-25.71
37	77.78	-44.8	83	68.79	-25.46
38	77.6	-44.11	84	68.58	-25.21
39	77.43	-43.44	85	68.37	-24.97
40	77.25	-42.79	86	68.16	-24.73
41	77.08	-42.15	87	67.95	-24.5
42	76.9	-41.53	88	67.74	-24.27
43	76.72	-40.93	89	67.53	-24.04
44	76.53	-40.34	90	67.32	-23.82
45	76.35	-39.77	91	67.11	-23.6
46	76.17	-39.21	92	66.9	-23.38

Row	Latitude	Longitude	Row	Latitude	Longitude
93	66.69	-23.17	142	56.11	-15.63
94	66.47	-22.96	143	55.89	-15.52
95	66.26	-22.75	144	55.67	-15.4
96	66.05	-22.55	145	55.45	-15.29
97	65.84	-22.35	146	55.23	-15.18
98	65.63	-22.15	147	55.01	-15.07
99	65.41	-21.96	148	54.79	-14.96
100	65.2	-21.77	149	54.57	-14.86
101	64.99	-21.58	150	54.35	-14.75
102	64.77	-21.39	151	54.13	-14.64
103	64.56	-21.21	152	53.91	-14.54
104	64.35	-21.03	153	53.69	-14.44
105	64.13	-20.85	154	53.47	-14.33
106	63.92	-20.68	155	53.25	-14.23
107	63.7	-20.5	156	53.03	-14.13
108	63.49	-20.33	157	52.81	-14.03
109	63.27	-20.17	158	52.59	-13.93
110	63.06	-20	159	52.37	-13.84
111	62.84	-19.84	160	52.15	-13.74
112	62.63	-19.67	161	51.93	-13.64
113	62.41	-19.51	162	51.71	-13.55
114	62.2	-19.36	163	51.49	-13.45
115	61.98	-19.2	164	51.27	-13.36
116	61.76	-19.05	165	51.05	-13.26
117	61.55	-18.9	166	50.83	-13.17
118	61.33	-18.75	167	50.61	-13.08
119	61.12	-18.6	168	50.39	-12.99
120	60.9	-18.45	169	50.17	-12.9
121	60.68	-18.31	170	49.95	-12.81
122	60.47	-18.17	171	49.73	-12.72
123	60.25	-18.03	172	49.51	-12.63
124	60.03	-17.89	173	49.28	-12.54
125	59.81	-17.75	174	49.06	-12.45
126	59.6	-17.61	175	48.84	-12.37
127	59.38	-17.48	176	48.62	-12.28
128	59.16	-17.35	177	48.4	-12.2
129	58.95	-17.22	178	48.18	-12.11
130	58.73	-17.09	179	47.96	-12.03
131	58.51	-16.96	180	47.74	-11.94
132	58.29	-16.83	181	47.51	-11.86
133	58.07	-16.7	182	47.29	-11.78
134	57.86	-16.58	183	47.07	-11.7
135	57.64	-16.46	184	46.85	-11.61
136	57.42	-16.33	185	46.63	-11.53
137	57.2	-16.21	186	46.41	-11.45
138	56.98	-16.09	187	46.18	-11.37
139	56.76	-15.98	188	45.96	-11.29
140	56.54	-15.86	189	45.74	-11.22
141	56.33	-15.74	190	45.52	-11.14

Row	Latitude	Longitude
191	45.3	-11.06
192	45.08	-10.98
193	44.85	-10.91
194	44.63	-10.83
195	44.41	-10.75
196	44.19	-10.68
197	43.96	-10.6
198	43.74	-10.53
199	43.52	-10.45
200	43.3	-10.38
201	43.08	-10.31
202	42.85	-10.24
203	42.63	-10.16
204	42.41	-10.09
205	42.19	-10.02
206	41.96	-9.95
207	41.74	-9.88
208	41.52	-9.81
209	41.3	-9.74
210	41.07	-9.67
211	40.85	-9.6
212	40.63	-9.53
213	40.4	-9.46
214	40.18	-9.39
215	39.96	-9.32
216	39.74	-9.26
217	39.51	-9.19
218	39.29	-9.12
219	39.07	-9.06
220	38.84	-8.99
221	38.62	-8.92
222	38.4	-8.86
223	38.18	-8.79
224	37.95	-8.73
225	37.73	-8.66
226	37.51	-8.6
227	37.28	-8.54
228	37.06	-8.47
229	36.84	-8.41
230	36.61	-8.34
231	36.39	-8.28
232	36.17	-8.22
233	35.94	-8.16
234	35.72	-8.09
235	35.5	-8.03
236	35.27	-7.97
237	35.05	-7.91
238	34.83	-7.85
239	34.6	-7.79

Row	Latitude	Longitude
240	34.38	-7.73
241	34.16	-7.67
242	33.93	-7.61
243	33.71	-7.55
244	33.48	-7.49
245	33.26	-7.43
246	33.04	-7.37
247	32.81	-7.31
248	32.59	-7.25
249	32.37	-7.19
250	32.14	-7.13
251	31.92	-7.07
252	31.69	-7.02
253	31.47	-6.96
254	31.25	-6.9
255	31.02	-6.84
256	30.8	-6.79
257	30.57	-6.73
258	30.35	-6.67
259	30.13	-6.62
260	29.9	-6.56
261	29.68	-6.5
262	29.45	-6.45
263	29.23	-6.39
264	29.01	-6.34
265	28.78	-6.28
266	28.56	-6.22
267	28.33	-6.17
268	28.11	-6.11
269	27.89	-6.06
270	27.66	-6.01
271	27.44	-5.95
272	27.21	-5.9
273	26.99	-5.84
274	26.76	-5.79
275	26.54	-5.73
276	26.32	-5.68
277	26.09	-5.63
278	25.87	-5.57
279	25.64	-5.52
280	25.42	-5.47
281	25.19	-5.41
282	24.97	-5.36
283	24.75	-5.31
284	24.52	-5.26
285	24.3	-5.2
286	24.07	-5.15
287	23.85	-5.1
288	23.62	-5.05

Row	Latitude	Longitude
289	23.4	-4.99
290	23.17	-4.94
291	22.95	-4.89
292	22.73	-4.84
293	22.5	-4.79
294	22.28	-4.74
295	22.05	-4.68
296	21.83	-4.63
297	21.6	-4.58
298	21.38	-4.53
299	21.15	-4.48
300	20.93	-4.43
301	20.7	-4.38
302	20.48	-4.33
303	20.25	-4.28
304	20.03	-4.23
305	19.8	-4.18
306	19.58	-4.13
307	19.36	-4.08
308	19.13	-4.03
309	18.91	-3.98
310	18.68	-3.93
311	18.46	-3.88
312	18.23	-3.83
313	18.01	-3.78
314	17.78	-3.73
315	17.56	-3.68
316	17.33	-3.63
317	17.11	-3.58
318	16.88	-3.53
319	16.66	-3.48
320	16.43	-3.44
321	16.21	-3.39
322	15.98	-3.34
323	15.76	-3.29
324	15.53	-3.24
325	15.31	-3.19
326	15.08	-3.14
327	14.86	-3.1
328	14.63	-3.05
329	14.41	-3
330	14.18	-2.95
331	13.96	-2.9
332	13.73	-2.85
333	13.51	-2.81
334	13.28	-2.76
335	13.06	-2.71
336	12.83	-2.66
337	12.61	-2.61

Row	Latitude	Longitude
338	12.38	-2.57
339	12.16	-2.52
340	11.93	-2.47
341	11.71	-2.42
342	11.48	-2.38
343	11.26	-2.33
344	11.03	-2.28
345	10.81	-2.23
346	10.58	-2.19
347	10.36	-2.14
348	10.13	-2.09
349	9.91	-2.05
350	9.68	-2
351	9.46	-1.95
352	9.23	-1.9
353	9.01	-1.86
354	8.78	-1.81
355	8.56	-1.76
356	8.33	-1.72
357	8.11	-1.67
358	7.88	-1.62
359	7.66	-1.58
360	7.43	-1.53
361	7.21	-1.48
362	6.98	-1.44
363	6.76	-1.39
364	6.53	-1.34
365	6.3	-1.3
366	6.08	-1.25
367	5.85	-1.2
368	5.63	-1.16
369	5.4	-1.11
370	5.18	-1.06
371	4.95	-1.02
372	4.73	-0.97
373	4.5	-0.92
374	4.28	-0.88
375	4.05	-0.83
376	3.83	-0.79
377	3.6	-0.74
378	3.38	-0.69
379	3.15	-0.65
380	2.93	-0.6
381	2.7	-0.55
382	2.48	-0.51
383	2.25	-0.46
384	2.03	-0.42
385	1.8	-0.37
386	1.58	-0.32

Table 4.3 Equatorial crossing longitude for paths over Indian region

Path Longitude		Path Longitude		Path Longitude	
380	43.08	427	52.142	474	61.205
381	43.273	428	52.335	475	61.398
382	43.465	429	52.528	476	61.591
383	43.658	430	52.721	477	61.784
384	43.851	431	52.914	478	61.976
385	44.044	432	53.107	479	62.169
386	44.237	433	53.299	480	62.362
387	44.43	434	53.492	481	62.555
388	44.622	435	53.685	482	62.748
389	44.815	436	53.878	483	62.941
390	45.008	437	54.071	484	63.133
391	45.201	438	54.264	485	63.326
392	45.394	439	54.456	486	63.519
393	45.587	440	54.649	487	63.712
394	45.779	441	54.842	488	63.905
395	45.972	442	55.035	489	64.097
396	46.165	443	55.228	490	64.29
397	46.358	444	55.42	491	64.483
398	46.551	445	55.613	492	64.676
399	46.743	446	55.806	493	64.869
400	46.936	447	55.999	494	65.062
401	47.129	448	56.192	495	65.254
402	47.322	449	56.385	496	65.447
403	47.515	450	56.577	497	65.64
404	47.708	451	56.77	498	65.833
405	47.9	452	56.963	499	66.026
406	48.093	453	57.156	500	66.219
407	48.286	454	57.349	501	66.411
408	48.479	455	57.542	502	66.604
409	48.672	456	57.734	503	66.797
410	48.864	457	57.927	504	66.99
411	49.057	458	58.12	505	67.183
412	49.25	459	58.313	506	67.375
413	49.443	460	58.506	507	67.568
414	49.636	461	58.698	508	67.761
415	49.829	462	58.891	509	67.954
416	50.021	463	59.084	510	68.147
417	50.214	464	59.277	511	68.34
418	50.407	465	59.47	512	68.532
419	50.6	466	59.663	513	68.725
420	50.793	467	59.855	514	68.918
421	50.986	468	60.048	515	69.111
422	51.178	469	60.241	516	69.304
423	51.371	470	60.434	517	69.497
424	51.564	471	60.627	518	69.689
425	51.757	472	60.819	519	69.882
426	51.95	473	61.012	520	70.075

Path Longitude		Path Longitude		Path Longitude	
521	70.268	570	79.716	622	89.743
522	70.461	571	79.909	626	90.514
523	70.653	572	80.102	627	90.707
524	70.846	573	80.295	628	90.9
525	71.039	574	80.487	629	91.093
526	71.232	575	80.68	630	91.285
527	71.425	576	80.873	631	91.478
528	71.618	577	81.066	632	91.671
529	71.81	578	81.259	633	91.864
530	72.003	579	81.452	634	92.057
531	72.196	580	81.644	635	92.25
532	72.389	581	81.837	636	92.442
533	72.582	585	82.608	637	92.635
534	72.775	586	82.801	638	92.828
535	72.967	587	82.994	639	93.021
536	73.16	588	83.187	640	93.214
537	73.353	589	83.38	641	93.407
538	73.546	590	83.573	642	93.599
539	73.739	591	83.765	643	93.792
540	73.931	592	83.958	644	93.985
541	74.124	593	84.151	645	94.178
542	74.317	594	84.344	646	94.371
543	74.51	595	84.537	647	94.563
544	74.703	596	84.73	648	94.756
545	74.896	597	84.922	649	94.949
546	75.088	598	85.115	650	95.142
547	75.281	599	85.308	651	95.335
548	75.474	600	85.501	652	95.528
549	75.667	601	85.694	653	95.72
550	75.86	602	85.886	654	95.913
551	76.052	603	86.079	655	96.106
552	76.245	604	86.272	656	96.299
553	76.438	605	86.465	657	96.492
554	76.631	606	86.658	658	96.685
555	76.824	607	86.851	659	96.877
556	77.017	608	87.043	660	97.07
557	77.209	609	87.236	661	97.263
558	77.402	610	87.429	662	97.456
559	77.595	611	87.622	663	97.649
560	77.788	612	87.815	667	98.42
561	77.981	613	88.007	668	98.613
562	78.174	614	88.2	669	98.806
563	78.366	615	88.393	670	98.998
564	78.559	616	88.586	671	99.191
565	78.752	617	88.779	672	99.384
566	78.945	618	88.972	673	99.577
567	79.138	619	89.164	674	99.77
568	79.33	620	89.357	675	99.963
569	79.523	621	89.55	676	100.155
				677	100.348

Path Longitude

678	100.541
679	100.734
680	100.927
681	101.119
682	101.312
683	101.505
684	101.698
685	101.891
686	102.084
687	102.276
688	102.469
689	102.662
690	102.855
691	103.048
692	103.24
693	103.433
694	103.626
695	103.819
696	104.012
697	104.205
698	104.397
699	104.59
700	104.783

**Table 4.4 Equatorial crossing time (GMT) for paths over Indian region
(Local time at descending node 10:30 hrs)**

Path Longitude	Path Longitude	Path Longitude
380 7:38	425 7:03	470 6:28
381 7:37	426 7:02	471 6:27
382 7:36	427 7:01	472 6:27
383 7:35	428 7:01	473 6:26
384 7:35	429 7	474 6:25
385 7:34	430 6:59	475 6:24
386 7:33	431 6:58	476 6:24
387 7:32	432 6:58	477 6:23
388 7:32	433 6:57	478 6:22
389 7:31	434 6:56	479 6:21
390 7:30	435 6:55	480 6:21
391 7:29	436 6:54	481 6:20
392 7:28	437 6:54	482 6:19
393 7:28	438 6:53	483 6:18
394 7:27	439 6:52	484 6:17
395 7:26	440 6:51	485 6:17
396 7:25	441 6:51	486 6:16
397 7:25	442 6:50	487 6:15
398 7:24	443 6:49	488 6:14
399 7:23	444 6:48	489 6:14
400 7:22	445 6:48	490 6:13
401 7:21	446 6:47	491 6:12
402 7:21	447 6:46	492 6:11
403 7:20	448 6:45	493 6:11
404 7:19	449 6:44	494 6:10
405 7:18	450 6:44	495 6:09
406 7:18	451 6:43	496 6:08
407 7:17	452 6:42	497 6:07
408 7:16	453 6:41	498 6:07
409 7:15	454 6:41	499 6:06
410 7:15	455 6:40	500 6:05
411 7:14	456 6:39	501 6:04
412 7:13	457 6:38	502 6:04
413 7:12	458 6:38	503 6:03
414 7:11	459 6:37	504 6:02
415 7:11	460 6:36	505 6:01
416 7:10	461 6:35	506 6:00
417 7:09	462 6:34	507 0:25
418 7:08	463 6:34	508 5:59
419 7:08	464 6:33	509 5:58
420 7:07	465 6:32	510 5:57
421 7:06	466 6:31	511 5:57
422 7:05	467 6:31	512 5:56
423 7:05	468 6:30	513 5:55
424 7:04	469 6:29	514 5:54

Path Longitude		Path Longitude		Path Longitude	
515	5:54	564	5:16	613	4:38
516	5:53	565	5:15	614	4:37
517	5:52	566	5:14	615	4:36
518	5:51	567	5:13	616	4:36
519	5:50	568	5:13	617	4:35
520	5:50	569	5:12	618	4:34
521	5:49	570	5:11	619	4:33
522	5:48	571	5:10	620	4:33
523	5:47	572	5:10	621	4:32
524	5:47	573	5:09	622	4:31
525	5:46	574	5:08	623	4:30
526	5:45	575	5:07	624	4:29
527	5:44	576	5:07	625	4:29
528	5:44	577	5:06	626	4:28
529	5:43	578	5:05	627	4:27
530	5:42	579	5:04	628	4:26
531	5:41	580	5:03	629	4:26
532	5:40	581	5:03	630	4:25
533	5:40	582	5:2	631	4:24
534	5:39	583	5:1	632	4:23
535	5:38	584	5:0	633	4:23
536	5:37	585	5	634	4:22
537	5:37	586	4:59	635	4:21
538	5:36	587	4:58	636	4:20
539	5:35	588	4:57	637	4:19
540	5:34	589	4:56	638	4:19
541	5:34	590	4:56	639	4:18
542	5:33	591	4:55	640	4:17
543	5:32	592	4:54	641	4:16
544	5:31	593	4:53	642	4:16
545	5:30	594	4:53	643	4:15
546	5:30	595	4:52	644	4:14
547	5:29	596	4:51	645	4:13
548	5:28	597	4:50	646	4:13
549	5:27	598	4:50	647	4:12
550	5:27	599	4:49	648	4:11
551	5:26	600	4:48	649	4:10
552	5:25	601	4:47	650	4:09
553	5:24	602	4:46	651	4:09
554	5:23	603	4:46	652	4:08
555	5:23	604	4:45	653	4:07
556	5:22	605	4:44	654	4:06
557	5:21	606	4:43	655	4:06
558	5:20	607	4:43	656	4:05
559	5:20	608	4:42	657	4:04
560	5:19	609	4:41	658	4:03
561	5:18	610	4:40	659	4:02
562	5:17	611	4:40	660	4:02
563	5:17	612	4:39		

Path Longitude

661	4:01
662	4:00
667	3:56
668	3:56
669	3:55
670	3:54
671	3:53
672	3:52
673	3:52
674	3:51
675	3:50
676	3:49
677	3:49
678	3:48
679	3:47
680	3:46
681	3:46
682	3:45
683	3:44
684	3:43
685	3:42
686	3:42
687	3:41
688	3:40
689	3:39
690	3:39
691	3:38
692	3:37
693	3:36
694	3:35
695	3:35
696	3:34
697	3:33
698	3:32
699	3:32
700	3:31

5 Data Products

5.1 Introduction

The philosophy behind the products defined for Cartosat-1 mission is:

- * Achieve the mission objective of meeting the users' data requirements in the application areas of Mapping, DEM generation, Terrain visualization etc.,
- * Provide continuity to existing products
- * Supply data products on par with other contemporary satellites

Data products are generated from Cartosat-1 mono or stereo data. Apart from standard products, the following new products are identified for Cartosat-1 mission

- * Ortho rectified product
- * Orthokit product (mono and stereo)

- * Area of Interest (AOI) products (Georeferenced)

In addition to the above, Stereo Strip Triangulation (SST) approach is adopted for Cartosat-1 mission by processing full pass stereo data using very precise Ground Control Points (GCPs). Using the SST approach, strip based Digital Elevation Model (DEM) are generated for the whole country, facilitating operational generation of ortho products.

5.2 Types of Products

Cartosat-1 data products are of two categories.

- * Standard product (raw, radiometrically corrected, georeferenced, orthokit, AOI products)

Sl. No.	Type of Product	Corrections applied
1	Raw product (Mono: Fore or Aft)	Stagger corrections for odd-even pixel shift, line loss corrections and No radiometric or geometric corrections (only for internal users),
2	Radiometrically corrected / Basic Stereo	Stagger corrections, line loss corrections, radiometric correction at scene level
3	Standard Georeferenced	Radiometric and geometric corrections (north-oriented) at scene level using System knowledge
4	Orthokit products (mono/stereo)	Radiometric corrections along with Rational Polynomial Coefficients (RPCs)
5	Ortho product	Terrain corrected products using TCPs and DEM from SST software
6	Area of Interest (AOI) products	Standard products – (Georeferenced) Covering any user desired polygonal area, multi-scene, multi-volume products, masking the areas outside user area of interest with packaging logically.

Table 5.1 Cartosat-1 Data Products

* ortho corrected product

Standard products (georeferenced and AOI based) are generated after accounting for radiometric and geometric distortions while precision products are ortho rectified. Ortho rectified products are corrected for terrain distortions and camera tilt effects with the help of control points and using SST based DEM. All cartosat-1 data products are supplied with 10 bit radiometry for both PAN Fore and Aft cameras. Table 5.1 gives the types of products supplied for Cartosat-1 mission.

5.2.1 Standard products

Standard products are corrected for radiometric distortions or both radiometric and geometric

distortions depending on the user requirements. Table 5.2 gives the details of standard products from Cartosat-1.

Area Of Interest (AOI) based products

These products are being introduced for the first time and cover user-specified geographic area.

Number of products :

If the user area is covered within a single scene (Figure 5.1) a Minimum Bounding Rectangular (MBR) sub-scene product is generated. If the user area boundary intersects with multiple scene boundaries (Figure 5.2), the MBR sub-scenes from each scene is generated and packaged together as a single product without mosaicing. The image file is provided in Geotiff or TIFF file format.

Area Coverage (Scene based/ Float)	Level of Processing	Format	Media	Accuracy specifications		Remarks
				Location accuracy	Internal Distortion	
1. Single Camera	RAW	LGSOWG	CDROM DVD/Disk	-	-	For internal users only
2. Scene/SAT Mono/Stereo*	RAD	LGSOWG	CDROM DVD/Disk	+250m**	Terrain dependent	Basic stereo pair
3. Scene/SAT (Mono) *	RAD	Orthokit ###	CDROMDVD/Disk	+250m**	Terrain dependent	Rad product with RPC file
4. Scene/SAT (Mono)*	Standard§ corrections Applied##	LGSOWG* GeoTIFF Fast Format	CDROM/DVD	+250m	Terrain dependent	Geo-Referenced product
5. Scene/SAT Mono*, AOI§	Standard Corrections Applied#	GeoTIFF	CDROM/DVD	+250m	Terrain dependent	Geo-Referenced product

includes AOI
 ## All standard corrected products are Geo-referenced.
 ### include RPC file and Meta file.
 § Minimum area of AOI is 25*25 Sq Km, supplied with Meta file. Maximum order 10,000 sq km.
 * Restricted Area Masking is done, wherever required and is available only to Indian users
 ** Location accuracy applicable after RPC correction

Table 5.2 Standard Products

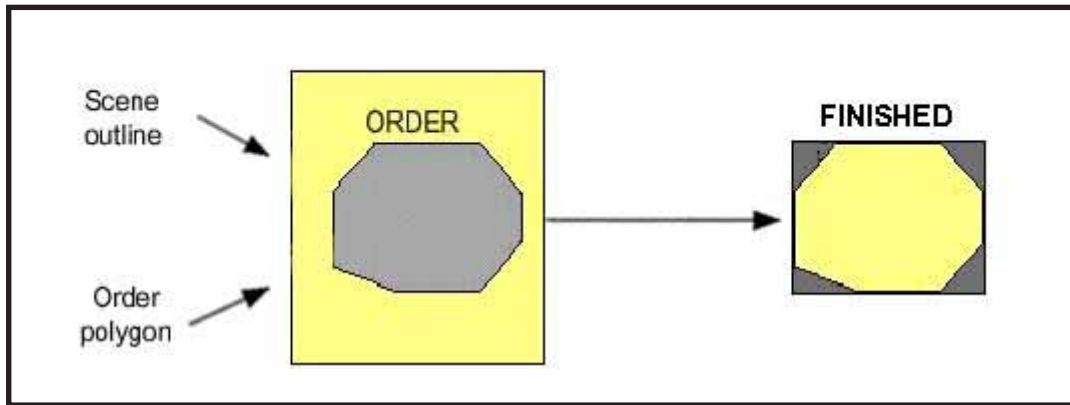

Figure 5.1 Outline of AOI Product (Single Scene)

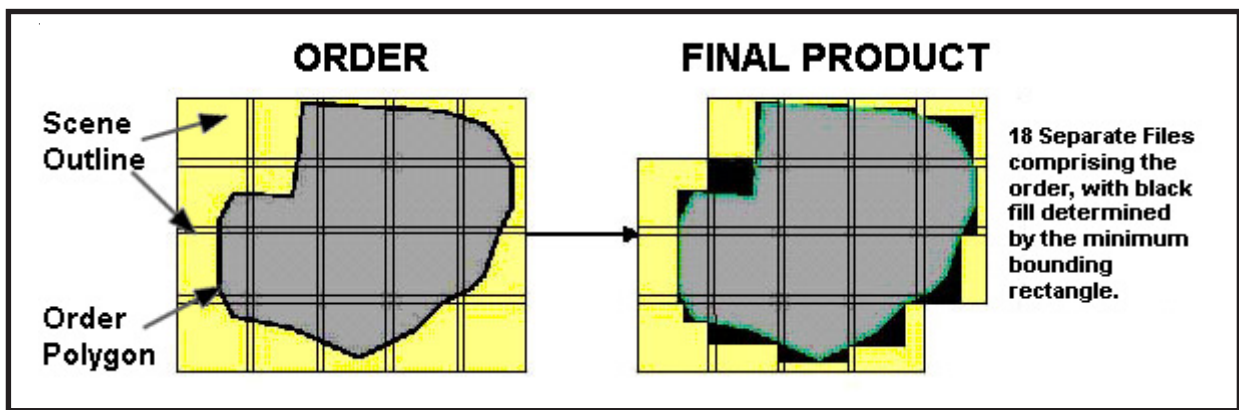
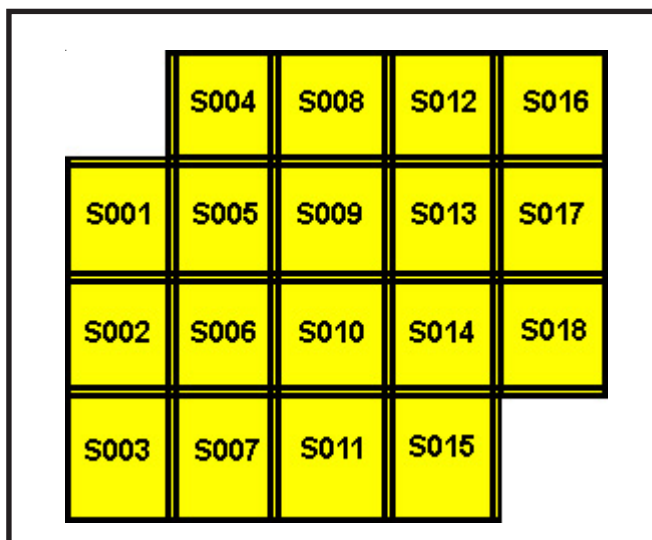

Figure 5.2 Outline of AOI Product (Multiple Scenes)



(a) Full Scenes



(b) Product Sub Scenes files

Figure 5.3 File naming of AOI product

The user-specified polygon (order polygon) is padded outside with extra buffer distance to ensure the area coverage, considering the accuracy specifications of the system corrected product. The modified polygon boundaries are used to define each constituent full/sub-scene product.

In case of AOI products, each product is supplemented by three Shape files namely

- a) AOI Ordered (Order Shape file)
- b) Input scene Shape file, and
- c) Final product shape file for each scene

Processing Level :

The AOI products are system level, geometrically corrected and north oriented products and are supplied as one or more rectangular full/sub-scene products without mosaicing.

Specifying the AOI :

The AOI is specified by the user as a single polygon boundary, referred to as order polygon. Order polygon can have a minimum of four nodes and a maximum of 1500 nodes. The area covered by the order polygon has to be a minimum of 25 x 25 sq. km and a maximum 10,000 sq. km. Each side of the polygon should be of length 5 km, at least. The polygon needs to be specified by geographic lat/long coordinates of each node in a clock-wise order in decimal degrees with 3-digit precision. The order polygon is normally specified in ESRI shape file format (*.shp, *.shx, *.dbf & *.prj) or optionally in ASCII format by the end-user.

Constituent Products :

The scenes, which intersect with the user area specified by the modified order polygon are increasingly numbered from top to bottom (north to south) beginning from left (west) and moving towards right (east). The scenes are so chosen so as to take into account the user specified constraints such as season and cloud cover and additional constraints of overlap with adjacent scenes. A minimum overlap of pixels is ensured between

individual adjacent products constituting the AOI product. The constituent products are numbered in a similar fashion as the scenes(Figure 5.3).

Deliverables :

Each constituent product of the AOI product is supplied as an individual GeoTIFF file. Apart from the multiple GeoTIFF files, AOI product comprises of one metadata file and three shape files specifying the

- (i) order polygon
- (ii) boundaries of constituent scenes and
- (iii) boundaries of constituent rectangular full/sub-scene products.

These three shape files are named order shape file, scene shape file and product shape file. For AOI products each scene is provided on separate media as independent products. The CDINFO File and Metadata File give details of each scene involved along with product Order/Scene/Product Shape files.

Orthokit Product :

Since the physical sensor model of Cartosat-1 is too complex to be communicated to the user community and this being a global mission, it becomes necessary to perform this task rather easily. The orthokit data product, being introduced for the first time from IRS missions, with Rational Polynomial Coefficients (RPC) model does this task with great efficiency and with no discernable loss of accuracy.

The purpose of delivering orthokit product to the users is to facilitate the user to produce their own orthorectified / Georectified products by using commercial off the shelf (COTS) software. Users can also increase the positional accuracy by using external digital elevation models (DEMs) and their own ground control points. An orthokit product consists of an image file (Geotiff format), a RPC file and a metadata file. Presently an orthokit product is scene based mono or stereo product. It is planned to provide AOI based orthokit products subsequently.

Deliverables :

Each product of the Orthokit product is supplied as an individual GeoTIFF file. Apart from the GeoTIFF files, Orthokit product comprises of one RPC file, one CDINFO file and one metadata file.

Strip DEM and Triangulated Control Points (TCPS) generated from Cartosat-1 stereo data are used for ortho rectification process. Table 5.3 gives the details of ortho rectified products.

5.2.2 Ortho rectified Products

Area Coverage	Level of Processing	Digital data Format	Media	Accuracy specifications	Location Distortion	Scale
Mapsheet based/Float 1:25,000 7.5' * 7.5'	(ortho) Terrain corrected	Precision	GeoTIFF	CDROM	± 25m	Around 10m
Float 5' x 5'	Precision (ortho) Terrain corrected	GeoTIFF	CDROM	± 25m	Around 10m	1:12,000
Float 3.75' x 3.75'	Precision (ortho) Terrain corrected	GeoTIFF	CDROM	± 25m	Around 10m	1:10,000
Float 2.25' x 2.25'	Precision (ortho) Terrain Corrected	GeoTIFF	CDROM	± 25m	Around 10m	1:5,000

Note:
All the Geocoded products ortho corrected.
* Restricted Area Masking done, wherever it is required

Table 5.3 Precision (ortho) Products

5.3 Product options

Map Projections	Resampling	Datum	Output Resolutions	Packaging levels	Output Media	Product formats
Polyconic, UTM,	Nearest Neighbour, Cubic Convolution,	WGS84, Everest	2.5 m, 1m(Spatial)	Individual or mono, Stereo pairs, Area of Interest (AOI), Orthokit usingRPCs	CD ROM, DVD, Disk	Fast Format, Super Structure (RAD GeoTIFF

Table 5.4 Product Options

Various products options considered for Cartosat-1 Data Products System are listed below (Table 5.4). They include resampling options, map projection options, output resolutions, different datum, output media, output product formats along with packaging levels.

5.4 Stereo Strip Triangulation

Stereo Strip Triangulation involves implementation of mathematical algorithms, handling large volumes of satellite data in raster format, for generation of countrywide DEM from Cartosat-1 stereo data. The major objectives of SSTS software are :

- (a) Creation of library of Triangulated Control Points (i.e. TCPs) for the entire country in stereo mode
- (b) Generation of coarse Digital Elevation Models (DEM) for individual segments of various stereo passes and
- (c) Refinement of satellite orientation parameters.

SST operations are carried out on pass-wise basis for stereo mode of imaging, wherein each stereo pass is broken into multiple segments. Each segment consists of pairs of stereo images (Fore and Aft images). Each segment is processed individually and in parallel with other segments. The length of the Segment is configurable (a maximum 500 km and a minimum 30 km).

The prerequisite for SSTS operations are well-distributed precise control points, stereo pair of full pass data and other ancillary parameters in the form of orbit, attitude and other mission parameters. The outputs of SSTS are DEM at the interval of 100m and triangulated control points of stereo pair. The TCPs and DEM are archived into different databases to enable generation of ortho products on an operational basis.

5.5 Digital Data products

All the digital products comprise of the actual image data, a CD-Info file, file format document and other files depending upon the type of product. All the system corrected data products are provided either in Fast Format or in GeoTIFF. Ortho, Orthokit and AOI products are provided in GeoTIFF format only. In the case of AOI and Orthokit products, in addition to the image data file, meta data, Shape and RPC files are also provided.

5.5.1 RPC File

This file contains the Rational Polynomial coefficients. This is a mathematical mapping from object space coordinates to image space coordinates. Since the RPC model, generally referred to as Rational Functional Model, is expressed simply as a ratio of two cubic polynomials. It is generic enough to be easily interfaced with most COTS photogrammetric packages. This is a text file named as BANDA_RPC.TXT. The format of RPC file is given in Table 5.5.

5.5.2 Metadata file Format

The meta data file describes key attributes about the image product, including product level, corner coordinates, projection information and time of acquisition. The metadata file is supplied for all AOI and Orthokit products. Details of file naming convention are available in the format document supplied with each product.

Field	Description	Range
LINE_OFF	Line offset, in pixels	Up to 2 decimal places
SAMP_OFF	Samp offset, in pixels	Up to 2 decimal places
LAT_OFF	Latitude offset, in degrees	Up to 8 decimal places
LONG_OFF	Longitude offset, in degrees	Up to 8 decimal places
HEIGHT_OFF	Height offset, in meters	Up to 3 decimal places
LINE_SCALE	Line Scale	Up to 2 decimal places
SAMP_SCALE	Samp Scale	Up to 2 decimal places
LAT_SCALE	Latitude Scale	Up to 8 decimal places
LONG_SCALE	Longitude Scale	Up to 8 decimal places
HEIGHT_OFF	Height Scale	Up to 3 decimal places
LINE_NUM_COEFF	LINE_NUM_COEFF. Twenty coefficients for the polynomial in the numerator of the equation.	Up to 15 decimal places
LINE_DEN_COEFF	LINE_DEN_COEFF. Twenty coefficients for the polynomial in the denominator of the equation.	Up to 15 decimal places
SAMP_NUM_COEFF.	SAMP_NUM_COEFF. Twenty coefficients for the polynomial in the numerator of the equation.	Up to 15 decimal places
SAMP_DEN_COEFF	SAMP_DEN_COEFF. Twenty coefficients for the polynomial in the denominator of the equation.	Up to 15 decimal places

Table 5.5 RPC File format description

6 INTRODUCTION TO SERVICES

6.1 Introduction

During the recent past, NRSA, an ISO 9001:2000 organization catering to - both aerial and satellite based remote sensing data requirements, has introduced a number of services, in tune with the emerging trends in technology. NRSA has introduced the Digital Browse Facility through Internet, product delivery through ISDN and FTPsite. NRSA has come out with the additional service of data ordering through net. Data ordering was, traditionally, done either by filling up the paper order form and sending by post or by sending a FAX message.

While we continue to support data ordering in the traditional mode, we now introduce the electronic ordering system integrated with browse and payload programming systems to enable the users to browse, select and order data online. Also facility to obtain the status of the user accounts and requests is made available online. this takes care of data ordering, introduction of data delivery through

network ensures that data reaches the users with the best turn around time possible in case of emergency.

Required information on how the various users - both Indian and Foreign - can procure Cartosat-1 data is also discussed.

For more information, users can contact the following address :

NRSA Data Centre
National Remote Sensing Agency
Balanagar, Hyderabad – 500 037.
Phone:040 – 23878560, 23884423, 23884424
Fax :040 – 23878664/23878158
E.mail : sales@nrса.gov.in
URL: www.nrса.gov.in

6.2 USER ORDER PROCESSING SYSTEM

6.2.1 Introduction

The User Order Processing System is an integrated web based application which facilitates data browsing and ordering through network for archived data and requesting for programmed acquisition (Figure 6.2.1).

Users, after browsing the images, using the various queries discussed in Section 6.3 and selecting the scenes, can place an order for the same using the ordering tools. Facility to obtain the status of user accounts and the orders placed is also available online. Registered users can also change their details like address and their login password and send general queries through e-mail.

6.2.2 User order processing

Upon connecting to the NRSA User order processing system site, the user is presented with a page with various links which enable the user to navigate through the application (Figure 6.2.2). If the user is new, he has to register himself for the ordering service to be enabled. While registering, the user has to agree to the terms and conditions displayed. A registration form is displayed in which he has to provide details like name, user identification (uid), password, user category, mailing address etc.,. Users have to remember their uid and password for future logins.

If the user is a registered user, he can sign in with his uid and password and enable the services.

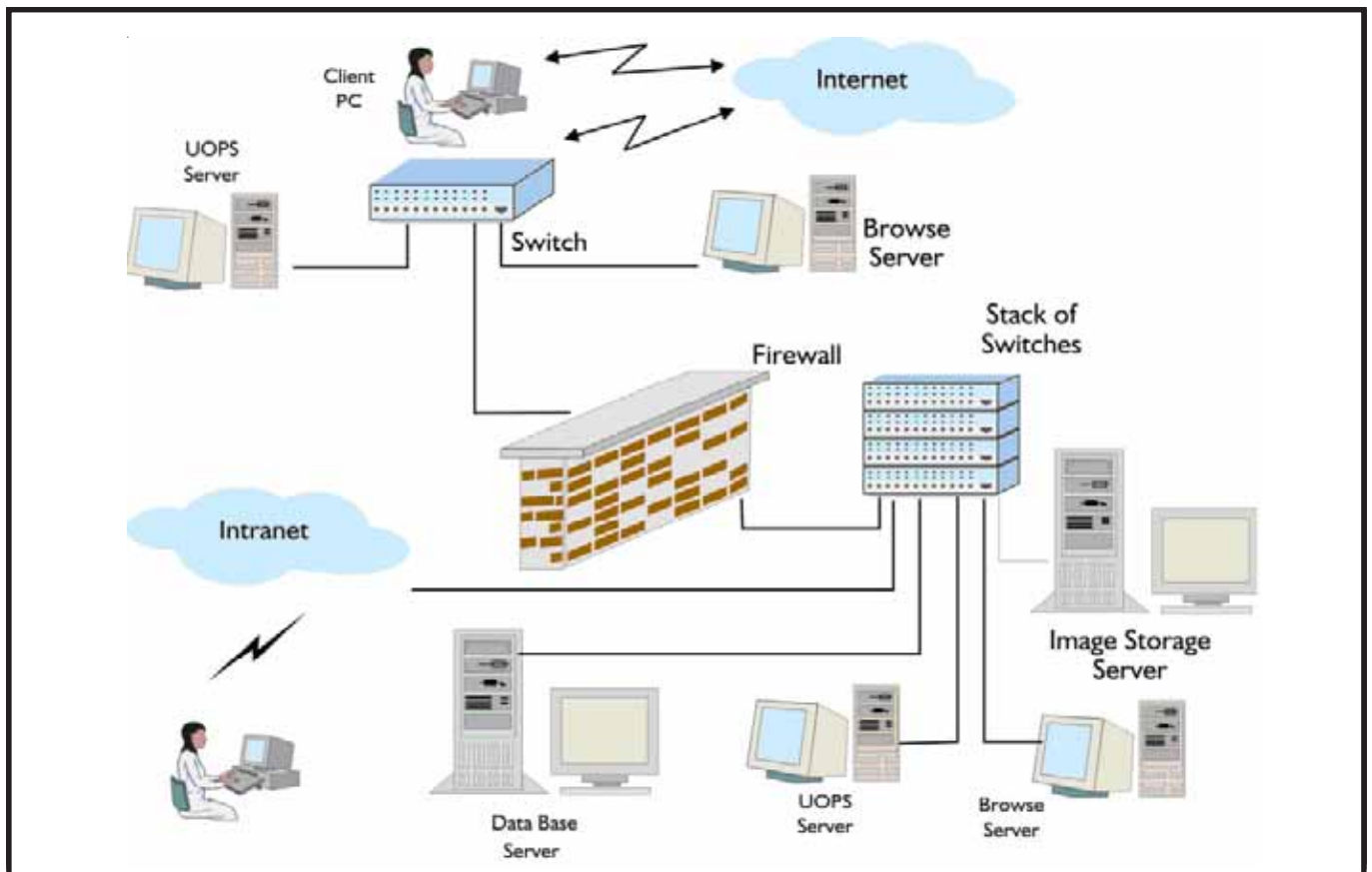

Figure 6.2.1 Block diagram of User Order Processing System

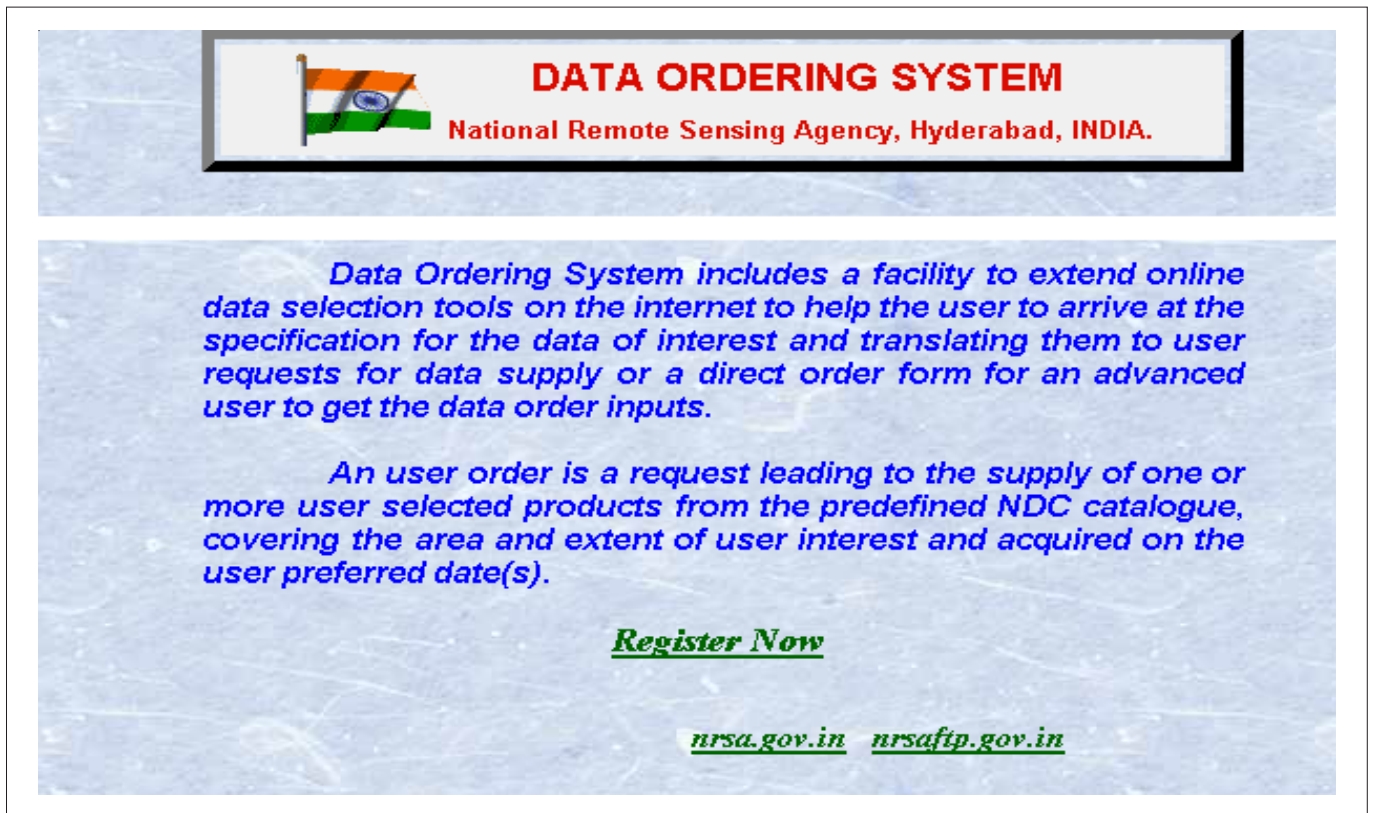

Figure 6.2.2 UOPS Home page

6.2.3 Services

On successful login, the user is presented with a page which has the options for placing order from the archives (Figure 6.2.3). The various services include data selection tools, ordering tools, order status display, request for restart of an order, product catalogue display and accounts related services. We shall now see how each of these can be used in selecting and ordering data.

Once the user clicks the option of “Order placing from archives”, he is presented with a page which gives the various options of data selection tools like point, location, geographical coordinages, shape file or map-based (Figure 6.2.4). Once the mode of input data is chosen, user has to input the appropriate

location information and period of interest. After this, the user is presented with a page which asks for the type of product i.e., Standard, AOI, Stereo etc.. (Figure 6.2.5). After the type of product is selected, the scenes covering the user’s area of interest during the desired period are shown (Figure 6.2.6).

Depending upon the coverage, provision to shift the scene is provided and user can view the shifted scene (Figure 6.2.7). After selecting the required scenes, the user is presented with a page which asks for the various product options like output media, map projection, enhancement, format, sampling technique, bands, correction level, quantity, priority and delivery mode in the case of digital products are requested for (Figure 6.2.8).

On providing the above information, a form



Figure 6.2.3 Page displaying the UOPS Services



Figure 6.2.4 Page displaying input mode options

Order Generation System

Order Type:	<input type="text" value="Scene based"/>	Satellite:	<input type="text" value="CARTOSAT-1"/>
Scene Type:	<input type="text" value="Single_Sensor"/>	Sensor:	<input type="text" value="PANA"/>
Selection Type:	<input type="text" value="Sngl Prd Type"/>	PrdType:	<input type="text" value="Standard"/>

Standard

7.5'*7.5' mapsheet geocoded

7.5'*7.5' floating geocoded

5'*5' floating geocoded

3.75'*3.75' floating geocoded

2.25'*2.25' floating geocoded

Figure 6.2.5 Page displaying product options

Satellite: CARTOSAT-1 Stereo PrdType: SR

User Area NWLat: 13.1959 NWLon: 77.3593 SELat: 12.7439 SELon: 77.8207

<p>08-JUN-2005 <input type="checkbox"/> Path: 544</p> <p><input type="checkbox"/> View PLD Scn 334 0% <input type="button" value="Shift All"/></p>	<p>25-JUN-2005 <input type="checkbox"/> Path: 544</p> <p><input type="checkbox"/> View PLD Scn 334 0% <input type="button" value="Shift All"/></p>	<p>30-JUN-2005 <input type="checkbox"/> Path: 544</p> <p><input type="checkbox"/> View PLD Scn 334 0% <input type="button" value="Shift All"/></p>
<p>08-JUN-2005 Path: 544</p> <p><input type="checkbox"/> View PLD Scn 335 0% <input type="button" value="Shift All"/></p>	<p>25-JUN-2005 Path: 544</p> <p><input type="checkbox"/> View PLD Scn 335 0% <input type="button" value="Shift All"/></p>	<p>30-JUN-2005 Path: 544</p> <p><input type="checkbox"/> View PLD Scn 335 0% <input type="button" value="Shift All"/></p>
<p>08-JUN-2005 Path: 544</p> <p><input type="checkbox"/> View PLD Scn 336 0% <input type="button" value="Shift All"/></p>	<p>25-JUN-2005 Path: 544</p> <p><input type="checkbox"/> View PLD Scn 336 0% <input type="button" value="Shift All"/></p>	<p>30-JUN-2005 Path: 544</p> <p><input type="checkbox"/> View PLD Scn 336 0% <input type="button" value="Shift All"/></p>
<p>08-JUN-2005 Path: 544</p> <p><input type="checkbox"/> View PLD Scn 337 0% <input type="button" value="Shift All"/></p>	<p>25-JUN-2005 Path: 544</p> <p><input type="checkbox"/> View PLD Scn 337 0% <input type="button" value="Shift All"/></p>	<p>30-JUN-2005 Path: 544</p> <p><input type="checkbox"/> View PLD Scn 337 0% <input type="button" value="Shift All"/></p>
<p>28-MAY-2005 <input type="checkbox"/> Path: 545</p> <p><input type="checkbox"/> View PLD Scn 334 0% <input type="button" value="Shift All"/></p>	<p>14-NOV-2005 <input type="checkbox"/> Path: 545</p> <p><input type="checkbox"/> View PLD Scn 334 0% <input type="button" value="Shift All"/></p>	
<p>28-MAY-2005 Path: 545</p> <p><input type="checkbox"/> View PLD Scn 335 0% <input type="button" value="Shift All"/></p>	<p>14-NOV-2005 Path: 545</p> <p><input type="checkbox"/> View PLD Scn 335 0% <input type="button" value="Shift All"/></p>	

Figure 6.2.6 Page displaying scenes covering the area of interest during the desired period

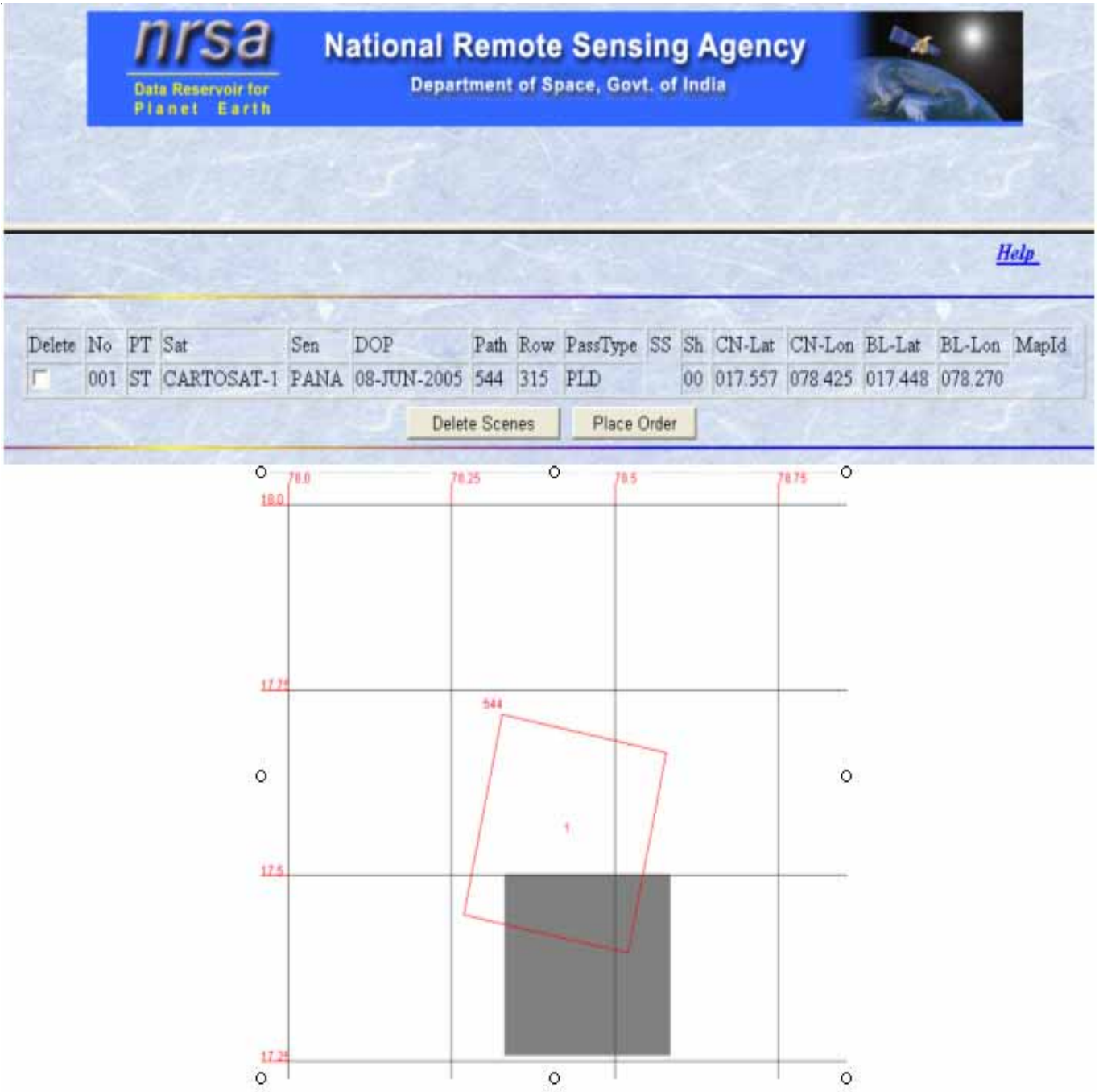

Figure 6.2.7 Page displaying selected scene and its layout



Data Reservoir for Planet Earth

National Remote Sensing Agency
Department of Space, Govt. of India



Selected Scenes

Satellite	Sensor	Subscene	DateOfPass	Path	OrbitNo	SegmentNo	StripNo	RowNo	ShiftValue	MapsheetNo	Position	Latitude	Longitude	Pass Type
CARTOSAT-1	PANA		08-JUN-2005	544	505			315	0		centre	17.557	78.425	PLD

Select Product Details

Product Type: STANDARD ▾ **Projection:** No Projection ▾

Sampling: No Resampling ▾ **Correction Level:** Raw ▾

DIGITAL PRODUCT DETAILS:

Enhancement: No Enhancement ▾ **Format:** LGSOWG/BSQ ▾

Media: CDROM ▾ **Band Combination:** All Bands

Ellipsoid/Datum: EVEREST ▾

Dispatch Mode: COURIER/ SPEED POST ▾ **Product Priority:** Normal ▾

No.Of Copies: 1 **Product Cost:** Actual Cost of the Product

Figure 6.2.8 Page displaying product options

Product Details Selection Input Form

Selected Scenes

Satellite	Sensor	Subscene	DateOfPass	Path	OrbitNo	SegmentNo	StripNo	RowNo	ShiftValue	MapsheetNo	Position	Latitude	Longitude	Pass Type	Quadrant No
CARTOSAT-1	PANA		08-OCT-2005	514	2313			308	0	47A16SW	southwest	19.00033813	72.7527	PLD	
CARTOSAT-1	PANA		11-FEB-2006	514	4180			308	0	47A16SE	southwest	19.00015115	72.8754	PLD	
CARTOSAT-1	PANA		22-FEB-2006	513	4343			309	0	47B13NW	southwest	18.87446943	72.7497	PLD	

Select Product Details

Product Type: 7.5min GEO CODED **Projection:** POLYCONIC

Sampling: Cubic Convolution **Correction Level:** Ortho Rectified (Internal DEM)

DIGITAL PRODUCT DETAILS:

Enhancement: No Enhancement **Format:** TIFF

Media: CDROM

PHOTOGRAPHIC PRODUCT DETAILS:

Enhancement: Corrected **Format:** BW Paper

Media: 960mm 4X

Figure 6.2.9 Page displaying details of the order

PI Number : 1442 PI Date : 14-AUG-2006 The Estimated PI Value : 114000.0 User Id : user4123

Item No	SI No Of Scenes	Estimated Request Value	Satellite	Season	Date Of Pass Path	Orbit Number	Segment No	Strip Row No	Product Code	User Priority	Quantity	Dispatch Mode	Sub Scene Value	Shift	Quadrant No	Mapsheet No	Mapsheet Quadrant
1	1	17000.0	CARTOSAT-1	PANA	08-OCT-2005	514		308	G4PC006TJ	Normal	1	COURIER/ SPEED POST	0	0	0	47A16SW	
2	1	17000.0	CARTOSAT-1	PANA	11-FEB-2006	514		308	G4PC006TJ	Normal	1	COURIER/ SPEED POST	0	0	0	47A16SE	
3	1	17000.0	CARTOSAT-1	PANA	22-FEB-2006	513		309	G4PC006TJ	Normal	1	COURIER/ SPEED POST	0	0	0	47B13NW	
4	1	21000.0	CARTOSAT-1	PANA	08-OCT-2005	514		308	G4PC01624	Normal	1	COURIER/ SPEED POST	0	0	0	47A16SW	
5	1	21000.0	CARTOSAT-1	PANA	11-FEB-2006	514		308	G4PC01624	Normal	1	COURIER/ SPEED POST	0	0	0	47A16SE	
6	1	21000.0	CARTOSAT-1	PANA	22-FEB-2006	513		309	G4PC01624	Normal	1	COURIER/ SPEED POST	0	0	0	47B13NW	

Figure 6.2.9 contd

displaying all the details of the products requested is displayed. At this stage, the user can confirm the request or add some more products to the list.

The products can be sent to different shipping addresses. All the products from the list of selected products for a given shipping address, are treated as one order. This way the list of selected products can result in more than one order, possibly with different shipping addresses. A page with all the information pertaining to an order is displayed (Figure 6.2.9).

Status of the order can be viewed online using the 'Display order status' option.

In case the user has any complaints regarding the dispatched products, he can use the 'Request for restart' option to intimate the same by selecting the product request and giving the reason.

A list of the product codes and the cost of each for a given satellite and sensor can be obtained using the 'Product catalog' option.

User accounts related information also can be obtained online. Provision exists for a new user to request for opening an account online by clicking the 'open new account' option.

An off-line user is one who has one or more account numbers with NDC but has been placing orders for data by filling a paper order form or by FAX. Such off-line users can transfer their existing accounts to the newly registered uid using the 'off-line user' option".

Details of the advance payments made can be sent using the 'Advance payment' link .

Accounts and transaction details can be viewed using the 'Account display' option.

Registered users can change their address and password using the 'Change Address' and 'Change password' options. Any further correspondence can be made using the 'Contact NRSA option'.

As already mentioned, the UOPS is an integrated package for data browsing, ordering through Internet, placing payload programming requests through net. Apart from the above services, the UOPS software has been designed to provide the following off-line services :

6.2.4 Order Processing and monitoring on Intranet by NDC

Order processing facility on Intranet enables NDC to monitor, distribute, process and dispatch the generated products to the customers.

6.2.5 Off-line Order placing by NDC

This system also includes necessary provisions to handle the user requests placed through conventional procedure into the system for further handling at NDC.

6.2.6 Stand Alone Services

In addition, this system handles data archival, account maintenance, report generation and other maintenance procedures required for the routine operations.

6.3 DIGITAL BROWSE FACILITY

6.3.1 Introduction

Before placing an order for data, the users need to browse through the data, to check for cloud and quality of the data. To meet this requirement, NRSA generates sub-sampled and compressed browse images along with necessary ancillary information. This facility is made available to users through Internet. The Browse facility has been integrated with data ordering and payload programming systems. Data can be browsed online and suitable scenes can be selected and converted into a data request by registered users who have an account with NDC.

Users can browse the scenes by submitting any of the following queries (Figure 6.3.1)

1. Search for images based on date of pass
2. Search for images based on path
3. Geographical area based query
4. Map sheet number based query
5. Location name based query
6. Point identification based query

6.3.2 Search for images based on date of pass

This Query is useful if the User wants to browse the images for a specific date. Users have to choose the satellite, sensor and the date of pass in dd-mmm-yyyy format (Figure 6.3.2) . For Example : 12-Apr-1998 (This field is case insensitive). If a wrong value entered, an alert is displayed asking the correct date.



Figure 6.3.1 Browse queries main form

When the date field is not entered at all, an alert message asking the date is displayed. However, a calendar is also provided along the date field for easy operation.

On clicking the path guide, the list of paths acquired for that day, satellite and sensor are displayed. Users have to select the desired path and enter the number of rows for which he would like to browse the scenes

and then click submit. While submitting the query if the User opts to see the thumb nail images, small images with meta information are displayed. Otherwise, a page with the list of scenes is displayed. On clicking on the desired scene details, the image along with meta information is displayed. The image can be viewed with various options like viewing with grid, viewing the scene by shifting by a percent (10 - 90 in steps of 10), view the



Figure 6.3.2 Date base query form

previous and next scenes.

6.3.3 Search for images based on Path

This Query is useful for viewing the images pertaining to a given path acquired on different dates (Figure 6.3.3). Users have to choose the satellite and sensor, enter path, start row, number of rows and date

range (Start-date and End-date) in dd-mmm-yyyy format. For Example : 12-Apr-1998 (This field is case insensitive). On submitting the query, a list of dates on which the desired path and rows have been acquired, are displayed. On selecting a date, details of the scenes are displayed. On selecting the desired scene, the image is displayed which can be viewed with various options. As in the case of date based query, the image can be viewed with various options like viewing with grid, viewing the scene by

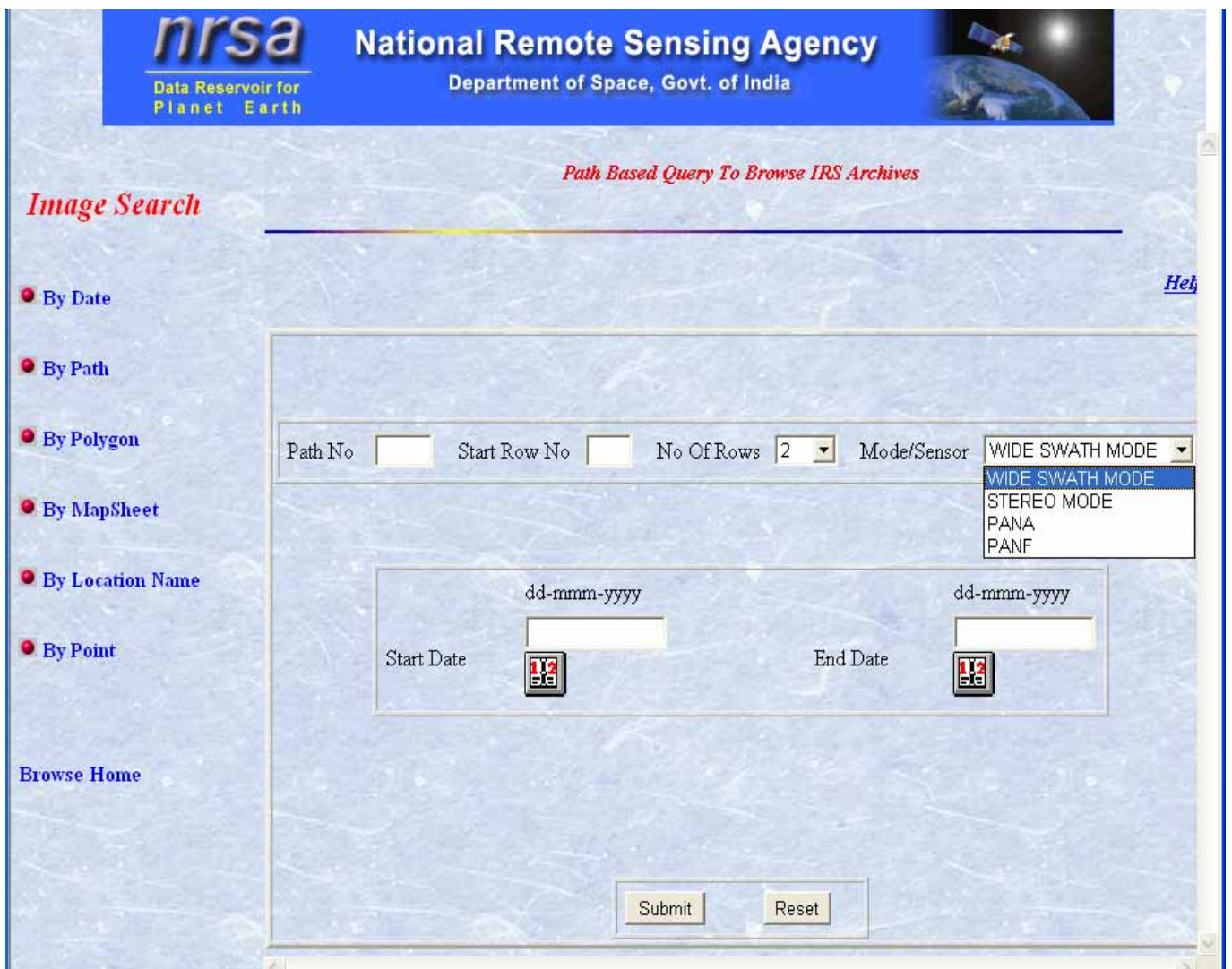

Figure 6.3.3 Path based query form

shifting by a percent (10 - 90 in steps of 10), view the previous and next scenes.

6.3.4 Geographical area based query

This option is useful if the user wants to browse the images for a given geographical area (a maximum

of 2°) (Figure 6.3.4). Users can input their area of interest either in terms of latitude/longitude in degrees, minutes or degrees decimal format of top left and bottom right corners.

On submitting the query, a form requesting the user to enter the period of interest is displayed. On submitting, a list of scenes covering the user's area of interest during the desired period, along with a

The screenshot shows the 'Geographical Area Based Query' form on the nrSA website. The header includes the nrSA logo and 'National Remote Sensing Agency, Department of Space, Govt. of India'. The form has a left sidebar with search options: 'By Date', 'By Path', 'By Polygon', 'By MapSheet', 'By Location Name', and 'By Point'. The 'By Point' option is selected. The main form area contains a 'Help' link and a search box with the following fields: 'Satellite' (CARTOSAT-1), 'Sensor' (WIDE SWATH), 'Area Around the Point' (50x50 Km), and 'LAT - LONGS of the POINT in' with radio buttons for 'Decimal' (selected) and 'Deg Min Sec'. Below this, there are input fields for 'Top Left' and 'Bottom Right' coordinates, each with 'Latitude' and 'Longitude' fields and dropdown menus for 'NORTH' and 'EAST'. At the bottom of the form are 'Submit' and 'Reset' buttons.

Figure 6.3.4 Geographical area based query form

graphical plot is displayed. The user can then, view the images and select.

6.3.5 Map sheet number based Query

Map sheet based geocoded products are one of the most popular products (Figure 6.3.5). So provision to query by map sheet number has been provided to facilitate easy querying by the user. In this case, apart from satellite, sensor, user has to select the map sheet number, either 1degree x 1 degree or 15'x 15' or 7 1/2' x 7 1/2'. On submitting the query, a form asking for the desired period is presented. On

The screenshot shows the NRSA National Remote Sensing Agency website interface. At the top, there is a header with the NRSA logo and the text 'National Remote Sensing Agency, Department of Space, Govt. of India'. Below the header, the page title is 'Map Sheet Number Based Query'. On the left side, there is a navigation menu with options: 'By Date', 'By Path', 'By Polygon', 'By MapSheet', 'By Location Name', and 'By Point'. The main content area contains a query form with the following fields: 'Satellite' (dropdown menu set to 'CARTOSAT-1'), 'Sensor' (dropdown menu set to 'STEREO'), 'MapSheet Type' (radio buttons for '1 Degree', '15'', and '7.5'' with '7.5'' selected), and 'MapSheet No' (dropdown menu set to '56', followed by three smaller dropdown menus set to 'K', '1', and 'SE'). At the bottom of the form are 'Submit' and 'Reset' buttons. A 'Browse Home' link is located at the bottom left of the page.

Figure 6.3.5 Map sheet number based query form

submitting, a list of scenes covering the map sheet, during the desired period, along with a graphical plot, is displayed. The user can then, view the images and select.

6.3.6 Latitude-longitude based query

This Query takes latitude and longitude of a single point and it maps to a square based on the extent chosen (Figure 6.3.6). This Query is useful if

particular area around a point is to be viewed.

User has to select the satellite, sensor, enter Latitude and Longitude of the point in degrees minutes or degrees decimal format and choose the extent of region desired. The extent of the region can be 50 x 50, 75 x 75, 100 x 100 or 250 x 250 Km. On submitting the query, a form asking for the desired period is presented. On submitting, a list of scenes covering the extent with the point as center, during

The screenshot shows the 'nrSA National Remote Sensing Agency' header with the tagline 'Data Reservoir for Planet Earth' and 'Department of Space, Govt. of India'. Below the header is the 'Lab-Long Based Query' section. On the left, there is a vertical menu with radio buttons for search methods: 'By Date', 'By Path', 'By Polygon', 'By MapSheet', 'By Location Name', and 'By Point'. The 'By Point' option is selected. To the right of the menu is a form titled 'Image Search' with a 'Help' link. The form contains several input fields: 'Satellite' (dropdown menu showing 'CARTOSAT-1'), 'Sensor' (dropdown menu showing 'WIDE SWATH'), and 'Area Around the Point' (dropdown menu showing '50x50' with 'Km' next to it). Below these is a section for 'LAT - LONGS of the POINT in' with two radio buttons: 'Decimal' (selected) and 'Deg Min Sec'. Further down, there are two input fields for 'Latitude' and 'Longitude', each with a dropdown menu for direction ('NORTH' and 'EAST' respectively). Above the input fields are placeholders '(xx.xxxx)' and '(xxx.xxxx)'. At the bottom of the form are 'Submit' and 'Reset' buttons. A 'Browse Home' link is located at the bottom left of the page.

Figure 6.3.6 Latitude-longitude based query form

the desired period, along with a graphical plot, is displayed. The user can then, view the images and select.

6.3.7 Location name based query

In case the user does not know anything other than the name of the location, he can use this query to browse the images covering the place during the desired period. The inputs to be provided by the user are satellite, sensor and the name of the place.

The user is presented with the details of the scene covering his place and the dates on which it was covered. The user can then, view the images and select.

6.3.8 Data ordering

As already mentioned in Section 6.2, the User Order Processing System is an integrated software package which facilitates the users to browse, select, place an order for a desired scene. After browsing the scene and feeling satisfied with the coverage, cloud cover and quality, the user can select the scene, save the details for placing an order for the same.

Figure 6.3.7 Location name based query form

6.4 PAYLOAD PROGRAMMING

6.4.1 Introduction

Cartosat-1 Payload Programming System (PPS) accepts requests from Users and the several International Ground Stations (IGS) for their future requirements of Cartosat-1 data acquisitions.

The satellite acquisition has to be programmed when

- * Stereo / wide swath imaging is requested
- * Data outside the visibility of the Indian ground station is required
- * A ground station requires Cartosat-1 data to be transmitted over their station visibility
- * There is a requirement for Merged data

Quicker revisit/Repeat coverage

The Cartosat-1 orbit has a 126-day cycle, which means that data are acquired over the same location every 126 days. However the platform can be given a roll tilt upto $\pm 23^\circ$ to provide a more frequent revisit

cycle (Figure 6.4.1).

Stereo / wide swath imaging

The spacecraft body is steerable to compensate the earth rotation effect and to force both Fore and Aft cameras to look at the same ground strip when operated in stereo mode. Simultaneous stereo pair acquisitions are of great advantage since the radiometric parameters of the images will be identical. The stereo pairs have a swath of 26 km and a fixed B/H ratio of 0.62.

Apart from the stereo mode, the satellite is also equipped to operate in the wide swath mode. When operated in this mode the satellite can be maneuvered such that image strips will fall side by side so that wider swath images of 55 Km are obtained by the cameras.

Merged data requirement

Acquisitions for requirements for merged data,

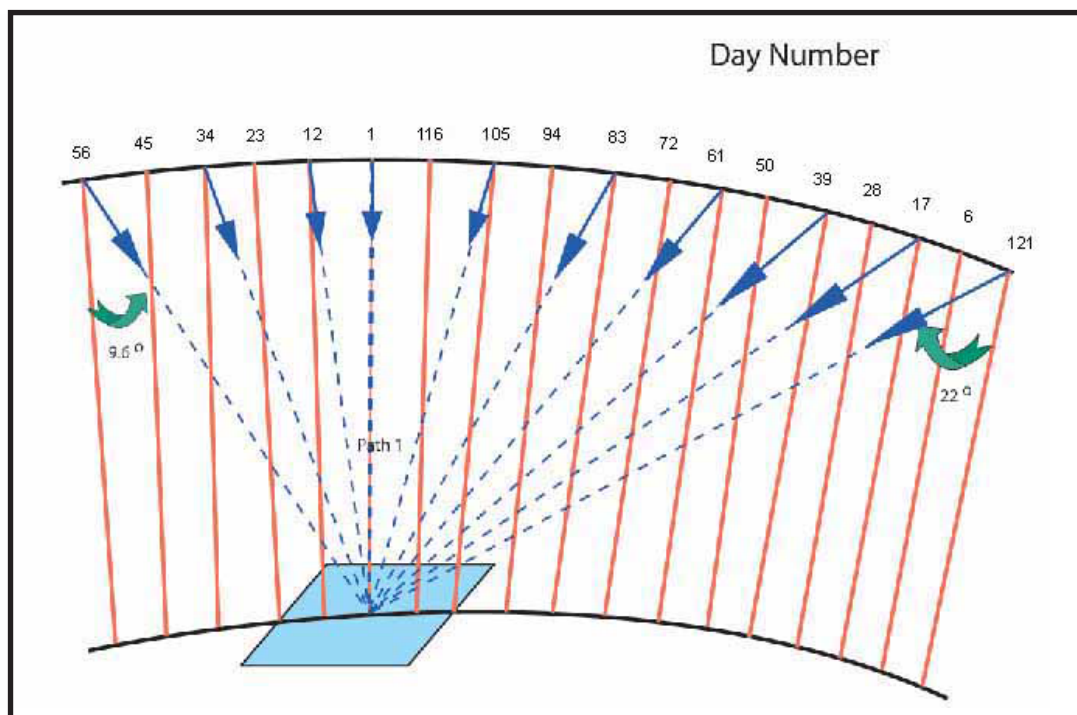

Figure 6.4.1 Roll tilt capability of Cartosat-1

wherein the high-resolution single band of Cartosat-1 PAN is merged with the medium resolution multi-spectral bands of other available sensors, can be planned.

On Board Solid State Recorder (OBSSR)

Data over nearly any part of the world can be acquired by the OBSSR. It has a capacity of 120 Gb. Data requirements outside the visibility of the Shadnagar ground station are programmed using the OBSSR and data recorded are down linked to the Shadnagar station, during night passes. One minute is the minimum length of data acquisition (Users need to purchase only what they need).

Ground station Requirements

In the Real-time mode, a ground station can acquire data from Cartosat-1 in stereo or wide swath modes.

6.4.2 Programming services

For future date acquisition, the satellite is programmed to collect data with a particular tilt and acquisition mode to service a User request.

While most of the cartographic applications are not time critical, it is essential to have cloudfree and good quality data over a given area. Efforts are made to acquire data within the user specified period by making a maximum of three attempts during the period. However, if the turn around time is critical, we offer urgent programming, in which case the request is serviced at the earliest possible opportunity. Urgent Programming attracts an acquisition fee.

6.4.3 Programming Activities

Programming requests from Users and ground stations are consolidated at NDC and an optimal acquisition plan for every pass is planned. This plan is arrived at, depending on availability of satellite resources, on the priorities of the requests, and the constraints of the satellite.

- * The acquisition schedule for a week is sent to Spacecraft Control Centre (SCC), ISTRAC at Bangalore.
- * The schedules are refined at SCC with the latest satellite parameters and the necessary commands for the satellite are generated.
- * The schedules are sent to GS and the state vectors are transmitted for acquisition of data.
- * Daily schedules are generated 2 days before the date of pass and can accommodate any urgent requests upto T-2 days where T is the date of acquisition.
- * After acquisition of the pass, NDC informs the User on the status of acquisition and data is generated on confirmation from the user.
- * After acquisition of the pass, GSs inform NDC and SCC of anomalies if any.

An overall flowchart of the programming activities is shown in Figure 6.4.1 and the timeline of the Programming activities are given in Table 6.4.1.

6.4.4 Programming Requests

General Users

Users can place their Programming Requests (PR) online through a web application, which is an integral part of the User Order Processing System (UOPS), or can send their requests to NDC by Fax or mail which in turn is processed by NDC through UOPS.

Users need to provide the following information while placing a Programming request (PR)

Area of Interest (AOI)

The geographical location of your area can be mentioned in terms of any of the following :

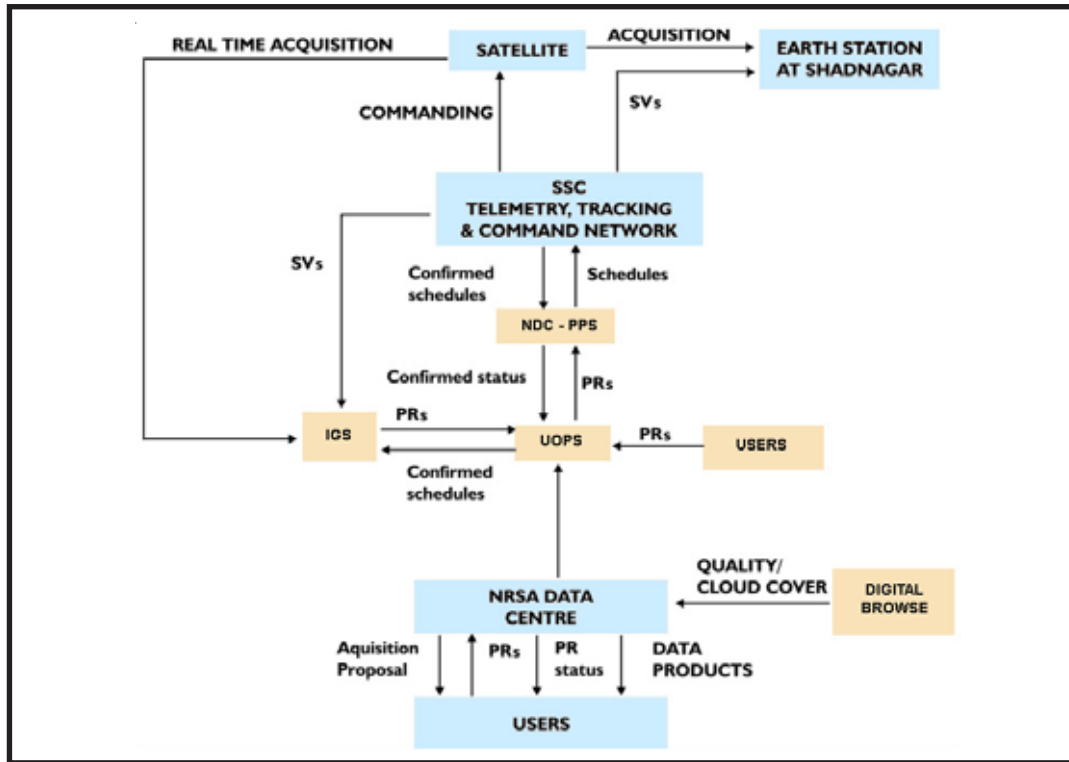

Figure 6.4.2 Overall flow of the programming activities

S No.	Activity	Time frame (days)	From	To
1.	Programming requests from Users	T-15	User	NDC
2.	Acquisition Proposal (on request)	T-13	NDC	User
3.	Confirmed programming request from User/IGS	T-10	User/IGS	NDC
4.	Acquisition plan for a week	T-7	NDC	SCC
5.	Confirmed schedules	T-6	NDC	
6.	Confirmed schedules T-5 Stations	T-5	NDC	All Ground
7.	Daily acquisition plan	D-2	SCC	
8.	State vectors	D-1	SCC	All Ground Stations
9.	Pass Performance report (by exception)	D+1	IGS	NDC/SCC
10.	Status of acquisition of user requests	D+1	NDC	User

T is the first day of the target week
D is the date of acquisition
A week is defined from Monday through Sunday

Table 6.4.1 Programming sequence and timeline

- * by a set of latitude/longitude co-ordinates (4 points) which bound the area
- * by SOI map sheet number
- * by a place name
- * by a point latitude/longitude co-ordinate.
- * Shape file

Period of interest

If data are required on a specific date because of simultaneous ground truth collection or other application requirements, it can be indicated by filling in the same date in the start and end date entries. Otherwise a range of dates can be specified during which data can be acquired.

It may be possible that the satellite may not be available for your request due to already scheduled requests. Advanced placing of request and selecting the appropriate programming service minimise the possibility of conflicts.

Mode of acquisition

Stereo/wide swath.

Type of service

Depending on the urgency of your requirement you may select between Normal and Urgent programming services.

A typical PR form is shown in Figure 6.4.2.

Before placing a confirmed PR, the user is shown the possibilities of acquisitions over the AOI within the period of interest (Acquisition Proposal) along with a request number. If the acquisition proposal meets the user requirement, the user needs to confirm the same to NDC/on-line, quoting the request number. The status of the request is then set to 'Confirmed'. The request takes varying status in the process of getting successfully serviced. Users can check for the status of their request online by keying in the request number. A typical status form is as shown in Figure 6.4.3.

The PRs from various users are carefully

studied and priorities are assigned depending on the order in which the PR is received, acquisition mode, type of service etc. Best efforts are made (a maximum of three attempts) to acquire the data over the required area as per user specifications.

After the satellite is programmed, the data are collected in real-time or through OBSSR, as per the request.

If the data are acquired successfully within the user-specified cloud limits and meets quality criteria set forth by NRSA, an acquisition report is sent to the user (online status for the request at this stage indicates 'completed'). The product is generated and despatched to the user. Purchase of data products is mandatory.

Even after three attempts if the acquisition is unsuccessful, the status of the request is set to 'unserviceable' and the request is closed. If the user still requires the data, a fresh request needs to be placed.

International Ground Station request

Ground stations interested in acquiring RESOURCESAT-1 data over their station can place their programming requests either through a Nodal ground station or can directly place their requests with NDC.

Nodal ground stations are responsible for the requests of all the ground stations handled by them. If there are any conflicting requests between ground station requests, the nodal ground station resolves conflicts before placing the requests of the ground stations to NDC.

Individual International Ground stations are responsible for the requests planned over their respective ground stations.

All ground stations have to be registered by NDC. NDC provides the User id and password for users to place their requests online. A Ground station can change the password assigned to it.

nrsa
Data Reservoir for Planet Earth

User Order and Payload Processing System

REQUEST PLACING FOR PAYLOAD PROGRAMMING

[Payload Prog Request](#)

- [Request Placing](#)
- [View Proposal](#)
- [View Request Status](#)
- [Request Canceling](#)
- [Sign Out](#)

[Help](#)

Request Form

Satellite:

Acquisition Mode:

Request Type:

User Priority:

Figure 6.4.3 Typical Programming Request form



nrsea
Data Reservoir for
Planet Earth

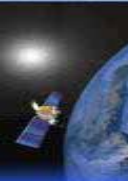

**User Order and Payload
Processing System**

PRODUCT REQUEST DETAILS

Req Id	Satellite	Acq Mode	Req Type	Req Date	User Priority	Start Date	End Date	Req Status	Est Cost	Sensor
05120027	IRS-P5	STR	POINT	13-DEC-2005	NORMAL	15-DEC-2005	26-DEC-2005	UNDER-PROCESS	60000.0	

SubReq Id	Center Latitude	Center Longitude	Min Acc Angle	Max Acc Angle	Terrain Type	SubReq Status
1	-26.1667	28.033	-23	23	MIXTURE	UNDER-PROCESS
2	-22.58	-43.283	-23	23	MIXTURE	UNDER-PROCESS
3	41.296	141.515	-23	23	MIXTURE	UNDER-PROCESS
4	39.291	140.901	-23	23	MIXTURE	UNDER-PROCESS
5	37.283	140.313	-23	23	MIXTURE	UNDER-PROCESS
6	35.496	139.811	-23	23	MIXTURE	UNDER-PROCESS

Product Code	Ellipsoid	Media Type	Delivery Mode	Quantity	Photo Band Type	Photo Bands	Product Priority
SR0000173	EV	DIGITAL	COURIER	1	ALL	ALL	ORDINARY

[Print the Request](#)

Figure 6.4.4 Typical Programming Request status form

Ground Station User Request Form

Station CHUNG-LI Satellite
Request Type

Start Date
End Date

Ground Station User Request Form

STATION : CHUNG-LI

DateOfPass: 20-Feb-2006 RequestType:PATH_ROW

Feasible Paths
Acquisition Mode

Target Specification
Pitch Bias

Encryption
Compression
Quarter No.

Figure 6.4.5 IGS Request form

Ground Station User Request Placing Form

STATION : CHUNG-LI

Date: 20-Feb-2006 Path: 811 AcqMode: STEREO ReqType:PATH_ROW InputMode:ROLLTILT

Start Latitude N End Latitude N Initial Terrain

Roll Bias:

Do you opt Terrain change? Yes Terrain Type Change Latitude N
Between 37.7067 and 6.9762

Accept

Ground Station User Request Form

STATION : CHUNG-LI

USER ID : ndc STATION CODE :CLT SATELLITE :IRS-P5

SL.NO	DATE OF PASS	PATH	ACQ MODE	REQUEST TYPE	START LAT	END LAT	LAT,LON / TILT	TERRAIN TYPE	CHANGED TERRAIN
1	20-Feb-2006	811	STEREO	PATH_ROW	37.7067	6.9762	0.0	Mixture	No Change

Confirm

[MODIFY BACK](#)

IGS request form (contd)

IGSs need to place, once in a week, programming requests pertaining to a target week (Monday-Sunday).

Nodal Ground Stations and other IGSs can use the 'Request placing' option of UOPS to place their programming requests. The Nodal ground station is provided with the list of station codes of the stations handled by them. The PR of each ground station defines the following parameters for a period of one week

- ☛ Station Id
- ☛ Date of pass
- ☛ Path number
- ☛ Mode (stereo/wide swath)
- ☛ Tilt or latitude/longitude of the target
- ☛ Start latitude and end latitude of acquisition

The form used by IGSs to place their request is

shown in Figure 6.4.4.

The IGSs are permitted to request for valid paths, within the visibility of the GS.

Each request of a station for a day and Path is assigned a 'Request Number'. The status of the request at this stage is set to 'Posted'.

IGSs can view the status of their requests online.

When a request is programmed, the status changes to 'Serviced'

NDC sends the schedules to the ground station, which indicates all the passes that have been planned for the station with the start and end times of acquisition.

IGSs can cancel a serviced request three days before the Date of Pass. State vector information is transmitted by SCC, ISTRAC to the ground stations on a daily basis.

IGSs send the pass performance report within 24 hours after the acquisition of the pass, only on exception, in case of anomalies to SCC and NDC. The IGSs have to send a monthly acquisition report of NDC for accounting purposes.

6.5 DATA DISSEMINATION

6.5.1 Introduction

NRSA Data Centre distributes IRS data pertaining to the area within the 5 degree coverage of Shadnager earth station to the Indian and foreign users.

Users outside India, but within the 5 degree coverage of Shadnager earth station, may approach NDC. Users outside the coverage of Shadnager earth station, should contact Antrix Corporation Limited who will service the request through NRSA or other receiving stations. Indian users who need the data outside the 5 degree elevation coverage of Shadnager earth station can approach NDC. These products are supplied by programming the satellites for data acquisition using OBSSR or through the Ground Stations set up by Antrix Corporation as appropriate.

6.5.2 Cartosat-1 data distribution

Various sources of Cartosat-1 data world-wide are as follows :

1. Indian users and users from neighbouring countries covered by Indian ground station, can obtain Cartosat-1 data products from NDC.
2. International users can get Cartosat-1 data products from the following source :

Antrix Corporation Ltd.
Antariksh Bhavan, New BEL Road
Bangalore - 560 094,
Karnataka, India
e-mail : antrix@bgl.vsnl.net.in
Phone : +91 80 23416274
 +91 80 22172189
Fax : +91 80 23418981

3. Antrix Corporation will however direct the international customers to appropriate reseller/ Ground station for products from different parts of the world.

4. It is possible to provide raw data for the user specified areas and period of interest along with the data processing software. This concept is known as virtual station. For such data requirements, users can contact Antrix Corporation Limited.

For specific information on availability of an IGS/ reseller or data of a particular location, users may contact Antrix Corporation Ltd. - the commercial wing of DOS.

6.5.3 Data down link access

Antrix Corporation Ltd, Department of Space, is responsible for data distribution outside the Indian visibility cone. For data down link access, users can contact Antrix Corporation Ltd.

6.5.4 Upgradation / Establishment of Ground Station

Antrix Corporation Ltd. has the required expertise to upgrade the existing ground station having X-band (8 to 8.4 GHz) reception capability to receive Cartosat-1 data or set up an entirely new reception and processing facility.

Antrix shall announce from time to time other agencies authorised to provide reception capability for Cartosat-1.

6.5.5 Data delivery

The data products are supplied to users either by courier or by speed post by default. In this mode of data supply, we need to add a minimum of 24 to 48 hours to the Turn Around Time of the data products to reach the user. Today we have reached a stage

where our TAT has improved from one month to few days to few hours of acquisition. We are able to achieve this due to technological advancements in data processing, data handling and possibility of data transfer through the net in near real time.

To expedite data delivery, data needs to be transferred through net. Currently, three modes are operational : Spacenet, ISDN and FTP.

Spacenet

Spacenet is a network for the DOS users only. All the DOS centers are connected through Spacenet and presently we are transferring data to SAC through Spacenet. The band width used for data transfer to SAC is 256 kbps.

ISDN

Any user having ISDN connectivity can approach NDC for the data transfer through net. The ISDN band width at NRSA is 2Mbps. It has a provision of Multi user services with user specific bandwidth. ISDN is a way of establishing high speed connections using regular phone lines.

This is a highly secured way of data transfer as encoding and decoding of the data can be done. In this mode of data delivery, separate directories are created for each user with user specific password and login. As soon as the data are copied on to the directory, the user is intimated about it. In case the volume of data is high, data are made available either band wise or user required area is extracted and put on the user directory.

The user can have an ISDN connection with a Router and Modem on PC based system. The charges are as per the normal telephone charges. There is no failure of network in case of ISDN unless and until the DOT is not down. At the user end the requirement for ISDN establishments are :

Remote location router with 2 x ISDN BRI ports 2x2

Mb leased line

2NT Device supplied by DoT with copper line laid

PC Server

16 Port Switch 10/100 Mbps

Multiple ISDN closed user group (CUG) support

The flow of the data transfer is shown in the Figure6.5.1

FTP site

In order to make the data available to the users within few hours of acquisition, a web based ftp site is being maintained which enables the user to down load the data using his normal Internet connection.

The web site is organized in such a way that it is a part of the NRSA web site with a link to the ftp site. The user is given an account based on user name and password. All the users who want to avail this facility should be registered with NDC. The registration is done offline. The users need to write

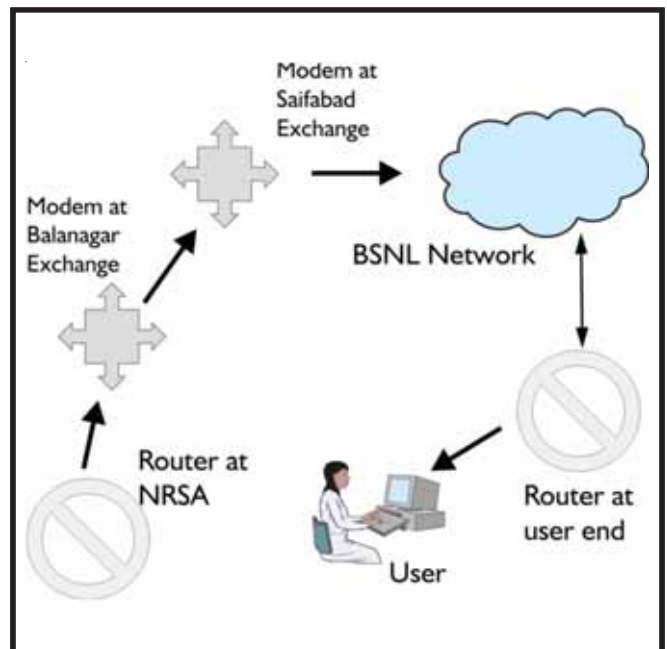

Figure 6.5.1 Flow of data transfer

to NDC or mail to NDC for registering themselves. While ordering the data, the user needs to specify whether the data have to be transferred through net or not. In case he needs the data through the net, he needs to mention the mode of transfer i.e., FTP or ISDN. Based on the data requirement, the data are generated and uploaded onto the respective directory of the user. As soon as the data are

uploaded on to the directory, the user gets a mail with his password. He needs to key the password while downloading the data. As the data to be transferred are voluminous, it takes a long time for the transfer. Therefore it has been decided to compress the data and put on the net for the user. Option to select the ratio of compression and the software to be used for compression is given to the user while placing an order for data products supply through net. The level of compression is chosen based on the application and also the level of degradation of the data, acceptable by the user.

Annexure I Cartosat-1 Product codes

Product type	Projection	Resampling	Enhancement	Processing level	Format	Size/media
ST- standard	0 No proj	0 No samp	00 No Enh	0 Raw	2 BW paper	4 960mm
SR-Stereo	P polyconic	C CC	01 - Enh	1 RAD	T GEOTIF	J CD
G4 -7.5 min mapsheet ortho	U UTM	N NN	DQ-DQE	G georeference	O ORTHOKIT	V DVD
J4-7.5 min float ortho				6 orthorectified	7 LGSOWG	D Disk
J5-5'x5' ortho					B fast format	
J6-3.75'x3.75' ortho						
J7-2.25'x2.25' ortho						

RAW	RAD	Mono Geo Tiff	Mono Fast format	Mono OrthoKit	Precision Geocoded (7.5' x 7.5 & 5' x 5')	Precision Geocoded (3.75' x 3.75 & 2.5' x 2.5')
ST000007J	ST000017J	STPC00GTJ	STPC00GBJ	STPC00GOJ	J4/G4PC00624	J6PC00624
ST000007V	ST000017V	STPC00GTV	STPC00GBV	STPC00GOV	J4/G4PC006TJ	J6PC006TJ
ST00DQ07J	SR000017J	STUC00GTJ	STUC00GBJ	STUC00GOJ	J4/G4UC00624	J6UC00624
ST00DQ07V	SR000017V	STUC00GTV	STUC00GBV	STUC00GOV	J4/G4UC006TJ	J6UC006TJ
ST00DQ07D	ST00DQ17J	STPN00GTJ	STPN00GBJ	STPN00GOJ	J4/G4PN00624	J6CC006TJ
	ST00DQ17V	STPN00GTV	STPN00GBV	STPN00GOV	J4/G4PN006TJ	J6CC00624
	SR00DQ17J	STUN00GTJ	STPK00GBJ	STPK00GOJ	J4/G4PK00624	J6PN00624
	SR00DQ17V	STUN00GTV	STPK00GBV	STPK00GOV	J4/G4PK006TJ	J6PN006TJ
	ST00DQ17D	STPK00GTJ	STUK00GBJ	STUK00GOJ	J4/G4UK00624	J6PK00624
	SR00DQ17D	STPK00GTV	STUK00GBV	STUK00GOV	J4/G4UK006TJ	J6PK006TJ
		STUK00GTJ	STUN00GBJ	STUN00GOJ	J4/G4UN00624	J6UK00624
		STUK00GTV	STUN00GBV	STUN00GOV	J4/G4UN006TJ	J6UK006TJ
					J5PC00624	J6CK006TJ
					J5PC006TJ	J6CK00624
					J5UC00624	J6UN00624
					J5UC006TJ	J6UN006TJ
					J5 PN00624	J6CN006TJ
					J5PN006TJ	J6CN00624
					J5PK00624	J7PC00624
					J5PK006TJ	J7PC006TJ
					J5UK00624	J7UC00624
					J5UK006TJ	J7UC006TJ
					J5UN00624	J7CC006TJ
					J5UN006TJ	J7CC00624
						J7PN00624
						J7PN006TJ
						J7PK00624
						J7PK006TJ
						J7UK00624
						J7UK006TJ
						J7CK006TJ
						J7CK00624
						J7UN00624
						J7UN006TJ
						J7CN006TJ
						J7CN00624

ANNEXURE II

CARTOSAT-1 DATA ORDER FORM

NRSA DATA CENTRE



National Remote Sensing Agency, Dept of Space, Govt. of India
 Balanagar, Hyderabad - 500 037
 Andhra Pradesh, India
 Phone : 91 40 2388 4423, 2388 4422
 Fax : 91 40 23878 664, 23878 158 .
 e-mail : sales@nrса.gov.in ; web site : www.nrса.gov.in

Duly filled order forms along with the certificate of undertaking are to be submitted in original to NRSA DATA CENTRE. Users are requested to retain a copy for their reference.

- 1 Details of Head of the Organization Shipping Details/Name of the contact person
 Name
 Designation
 Organization
 Address
 City/state
 Phone/Fax
 pin code
 e-mail
2. Status of the User Organization
3. User account number at NDC existing / new account no.
 please write new account if no account exists with NDC
4. Project name & End Use
5. Area of Interest (Please provide using one of the options listed below. Coordinates must be in Deg decimals)

Minimum Bounding	Center Point	Path / Row & Date of pass	Map sheet Based
Coordinates			
UL latitude	Latitude /Longitude		SOI Map sheet number
UL longitude			
LR latitude			
LR longitude			
Shape file			

(Geographic coordinates and no projection. Send it as a mail attachment four files shp, shx, dbf and prj)

6. Archived data (Browse Checked) YES/NO
 If no Start date End date
 Fresh Collects (tentative cloud free period) Start date End date
- 7a. Type of product
 2.5m geo-referenced MONO
 2.5m MONO ORTHO KIT with RPC
 2.5m Stereo ORTHO KIT with RPC
 Ortho products 7.5' 5' 3.75' 2.25'
- 7b. Digital or photo products (D/P)
 Resampling CC, NN
8. Priority With in 24 hours (100% additional cost)
 With in 72 hours (50% additional cost)
 Normal
9. File format Only GeoTIFF
10. Delivery Media CD OR DVD
11. Application/ end use of the data.
 Any Other: Please specify

Kindly fill the relevant certificate-1 or Certificate-2 and submit along with the order form.

It is confirmed that The Terms and Conditions as specified in the general information are accepted in full.

Signature :
 (Head of Organization)
 Date:
 Seal:

(In case the data is requested by a private company/ academic institution then the order form is also required to be endorsed as under by the head of the Govt Organization, along with Certificate II as an enclosure).

Signature
 Name:
 Designation of Head of the Govt. Organization
 Complete Address:
 Date and Seal:

CERTIFICATE 1
(Refer Sl. No. 3 of order form).

STATUS OF ORGANIZATION

This is to certify that _____
 _____ (name of organization) located at _____

 _____ (registered office address) belongs to the following

category :

- Academic institution recognized by _____
- Private Company/Corporation _____
- State Govt / Central Govt / DOS _____

It is certified that we need High Resolution Cartosat data for our own use/ use by M/s _____

 (name of organization with address) for the purpose of _____

 (please specify nature of application).

UNDERTAKING FOR SAFE CUSTODY OF DATA

Upon completion of the project, the data will be under the safe custody of the following senior official identified by the Company/Institute.

Official's name and address :

(Signature of the Head of the Company/Institute)

Name :
 Designation :
 Organization:
 Address & Seal :
 Date :

CERTIFICATE 2

(Refer Sl. No. 10 of order form).

AUTHORISATION CERTIFICATE FROM GOVERNEMENT ORGANISATION

(To be submitted with order form in case data is required by a private /academic organization undertaking a project or development work for a government organization)

This is to certify that _____

(name of organization) located at _____

(registered office address) is a Government of India/ Government of _____
 (name of State/Union Territory) / Autonomous Organisation under the Department of _____
 _____, Government of _____/Public Sector Undertaking belonging to _____
 _____ (strike out whatever is not applicable).

It is certified that we hereby authorize M/s _____

_____ (name of private/academic organization) to procure CARTOSAT-1 data for covering _____ area of interest _____

_____ for the purpose of _____

_____ (specify nature of application). Upon completion of the project, we will collect the specified CARTOSAT-1 data and retain it with us and agree to abide by all the terms and conditions for the supply of CARTOSAT-1 data as indicated in the order form.

Signature :
 Name :
 Designation :
 (Head of Organization)
 Organization :
 Address :
 Date & Seal

General Information and Terms and Conditions

CARTOSAT-1, the 2.5 meter resolution satellite with stereo capability was successfully launched, on May 05th 2005.

Mission Specifications : CARTOSAT-1 mission provides

- panchromatic (single band - black and white) images with a spatial resolution of 2.5 meter in the band width 0.5-0.85 microns The data is collected in **10 bits** and therefore has an excellent radiometric resolution as well. The satellite is an agile satellite and can be programmed to acquire data over any area of user interest. It has a swath of 26.8 km.

Who can buy CARTOSAT-1 data ?

CARTOSAT-1 data will be made available to all users for various developmental and application requirements. The following are the guide lines for data dissemination

- Cartosat-1 Data (2.5 m resolution) can be distributed to users after screening and ensuring that sensitive areas are excluded.
- Request for data for all users must be received in the prescribed form duly authorized by the head of the organization who shall be responsible to state the end application and identify a senior official for safe keeping of the data.
- Government users can obtain the data without any further clearance.
- Private sector agencies, recommended by at least one government agency for supporting developmental works can obtain it without any further clearance.
- For other private, academic, non-government the data can be distributed after clearance from a high level committee

How to order CARTOSAT-1 data ?

Users are requested to indicate their area and period of interest in the prescribed **order form** along with their acceptance of the terms and conditions for supply of CARTOSAT1- data by NRSA. Upon receipt of this order form from the user, NRSA – NDC will give a technical proposal with dates and area in sq km.

User can then confirm the order by signing on the technical/ commercial proposal (sent by NRSA) and arranging for 100 % advance payment to NRSA through a demand draft in favour of National Remote Sensing Agency, Balanagar, Hyderabad.

Area of Interest (AOI) :

- The vertices/side of the AOI must be more than 15 km apart. A shape file should not exceed 1500 points.
- For all AOI based products, if an AOI is covered by both archived and fresh data, the pricing will be based on the percentage of archived/fresh collects. If the archived data is < 30%, the entire AOI will be charged as per fresh collects price.
- Minimum order is a single image of size is 625 sq. km and order must be a contiguous area. Maximum order area is 10,000 sq km.

Product type:

Please refer to the CARTOSAT-1 users handbook hosted at www.nrsa.gov.in

CONDITIONS OF SALE:

- All products are sold for the sole use of purchasers and shall not be loaned, copied or exported without express permission of and only in accordance with terms and conditions if any, agreed with the NRSA Data Center, National Remote Sensing Agency, Dept. of Space, Govt. of India.
- Complaints and Inspection: No complaint related to the quality and/or quantity of the products will be entertained unless the complaint is lodged at NDC within 30 days from the date of receipt of data. On acceptance of the complaint, products can be returned after confirmation by NDC. If the rejections are accepted by NDC, all attempts will be made to provide similar/equivalent data products.
- The purchaser is responsible for any use of the data products purchased from NDC, which has no liability or responsibility for the fitness of the products for any particular use. Consequently, the purchaser waives all claims against NDC.
- Supply of data products on the price list are governed by these general terms with 100% advance payment. No contrary terms or conditions of the purchaser are binding on the NRSA Data Centre. The data will be supplied through speed post or couriers or net. It may be noted that **some part of user area may not be supplied** as it comes under sensitive area category.

License:

NRSA provides single user license only. NRSA, licenses satellite data to end users, rather than selling ownership rights to the data. The primary distinction is that a standard end user license permits use of data but prohibits distribution, resale, reproduction, etc.

Warranty: As per the return policy of NRSA

ANNEXURE - III

ACRONYMS

AC	Alternate Current	FSC	Frame Sync Code
ADIF	Ancillary Data Information File	GCP	Ground Control Point
A/D	Analog to Digital	GDQE	Geometric Data Quality Evaluation
AH	Ampere Hour	GPS	Global positioning system
AOCS	Attitude and Orbit Control System	G/T	Gain/Noise Temperature
AOS	Acquisition of Signal	GMT	Greenwich Meridian Time
AWIFS	Advanced Wide Field Sensor	HDT	High Density Tape
BAS	Browse Archival System	HDTR	High Density Tape Recorder
BCD	Binary Coded Decimal	HK	House Keeping
BCH	Binary Coded HexaDecimal	HP	Horse Power
BIL	Band Interleaved by Line	Hz	Hertz
BPSK	Bi-Phase Phase Shift Key	IGS	International Ground Station
BSQ	Band SeQential	IMGY	Image data file in UCCT
B/H	Base/Height	IIMS	Integrated Information Management System
B/W	Black & White	IPS	Inches Per Second
CC	Cubic Convolution	IR	Infra-Red
CCD	Charge Coupled Device	IRS	Indian Remote Sensing satellite
CFRP	Carbon Fibre Reinforced Plastic	ISAC	ISRO Satellite Centre
DAQLB	Data Archival and Quick Look Browse	ISRO	Indian Space Research Organisation
DGPS	Differential Global Positioning System	IST	Indian Standard Time
DLT	Digital Linear Tape	ISTRAC	ISRO Telemetry, Tracking and Command Network
DMCR	Dedicated Mission Control Room	JPEG	Joint Photographic Experimental Group
DN	Digital Number	KB	Kilo Bytes
DOS	Department Of Space	KHz	Kilo Hertz
DPGF	Data Products Generation Facility	Km	Kilometer
DPS	Data Processing System	Lat	Latitude
DTM	Digital Terrain Model	LAN	Local Area Network
DQE	Data Quality Evaluation	LBT	Low Bit rate Telemetry
dB	Decible	LCC	Lambertian Conformal Conic projection
dBm	Decible-milliwatt	LFFR	Large Format Film Recorder
dBw	Decible-watt	LED	Light Emitting Diode
deg	Degree	LGSOWG	Landsat Ground Station Operators Working Group
ECL	Emitter Coupled Logic	LISS	Linear Imaging an Self Scanning
EM	Electro-Magnetic	LOS	Loss of Signal
EOM	Electro-Optic Module	LSB	Least Significant Bit
EOF	End Of File	LTC	Light Transfer Characteristics
EOL	End Of Line	LUT	Look-Up Table
FCC	False Colour Composite	Lon	Longitude
FM	Frequency Modulation		
FSKM	Frequency Shift Key Modulation		

MAR	Mission Analysis Room
MCR	Mission Control Room
MB	Mega Bytes
MCC	Mission Control Centre
MFPH	Multi-mission Frontend Processing Hardware
MHz	Mega Hertz
MOS	Modular Opto-electronic Scanner
MSB	Most Significant Bit
MSBR	Multi frequency Scanning Radiometer
ms	milli second
MTF	Modulation Transfer Function
mw	milli watt
Mx	Multi-spectral
N	Newton
ND	Neutral Density
NB	Narrow Band
NDC	NRSA Data Centre
NIR	Near Infra Red
NN	Nearest Neighbour
NNRMS	National Natural Resources Management System
NRSA	National Remote Sensing Agency
OBTR	On-Board Tape Recorder
OCM	Ocean Colour Monitor
OSR	Optical Solar Reflectors
PC	Personal Computer
PCT	Photo Compatible Tape
PCM	Pulse Code Modulation
PM	Phase Modulation
PoI	Polyconic
PPS	Payload Programming System
PR	Programming Request
PS	Polar Stereographic
PSLV	Polar Satellite Launch Vehicle
PSK	Phase Shift Key
PSM	Payload Steering Mechanism
QAS	Quality Assurance Scheme
QC	Quality Control
QHS	Query Handling System
QL	Quick Look
QPSK	Quadrature Phase Shift Keying

RAID	Redundent Array of Independent Disks
RCS	Reaction Control Systems
RDQE	Radiometric Data Quality Evaluation
RF	Radio Frequency
RHC	Right Hand Circular
RMS	Root Mean Square
RNRZ(L)	Randomised Non-Return to Zero (level)
RNRZ(S)	Randomised Non-Return to Zero
RPM	Rotations Per minute
RRSSC	Regional Remote Sensing Service Centre
RSS	Root Sum Square
RST	Raw Star Sensor
SAC	Space Applications Centre
SAT	Shift Along the Track
S/c	Spacecraft
SCC	Spacecraft Control Centre
SCR	Silicon Controlled Rectifier
SNR	Signal to Noise Ratio
SPS	Satellite positioning System
SOM	Space Oblique Mercator
SOI	Survey of India
SST	Stereo Strip Triangulation
SWIR	Short Wave Infra Red
SWR	Square Wave Response
TC	Tele Command
TCG	Time Code Generator
TCT	Time Code Translator
TRAI	Trailer file in UCCT
TIU	Telemetry interface unit
TTC	Telemetry, Tracking and Command
TWTA	Travelling Wave Tube Amplifier
UT	Universal Time
UTM	Universal Transverse Mercator